

SPECTROSCOPY

europa

Informing European spectroscopists for over 40 years

Calibration for thin film characterisation
Recent trends in XRF: nanomaterials
Throwing light on corrosion inhibition

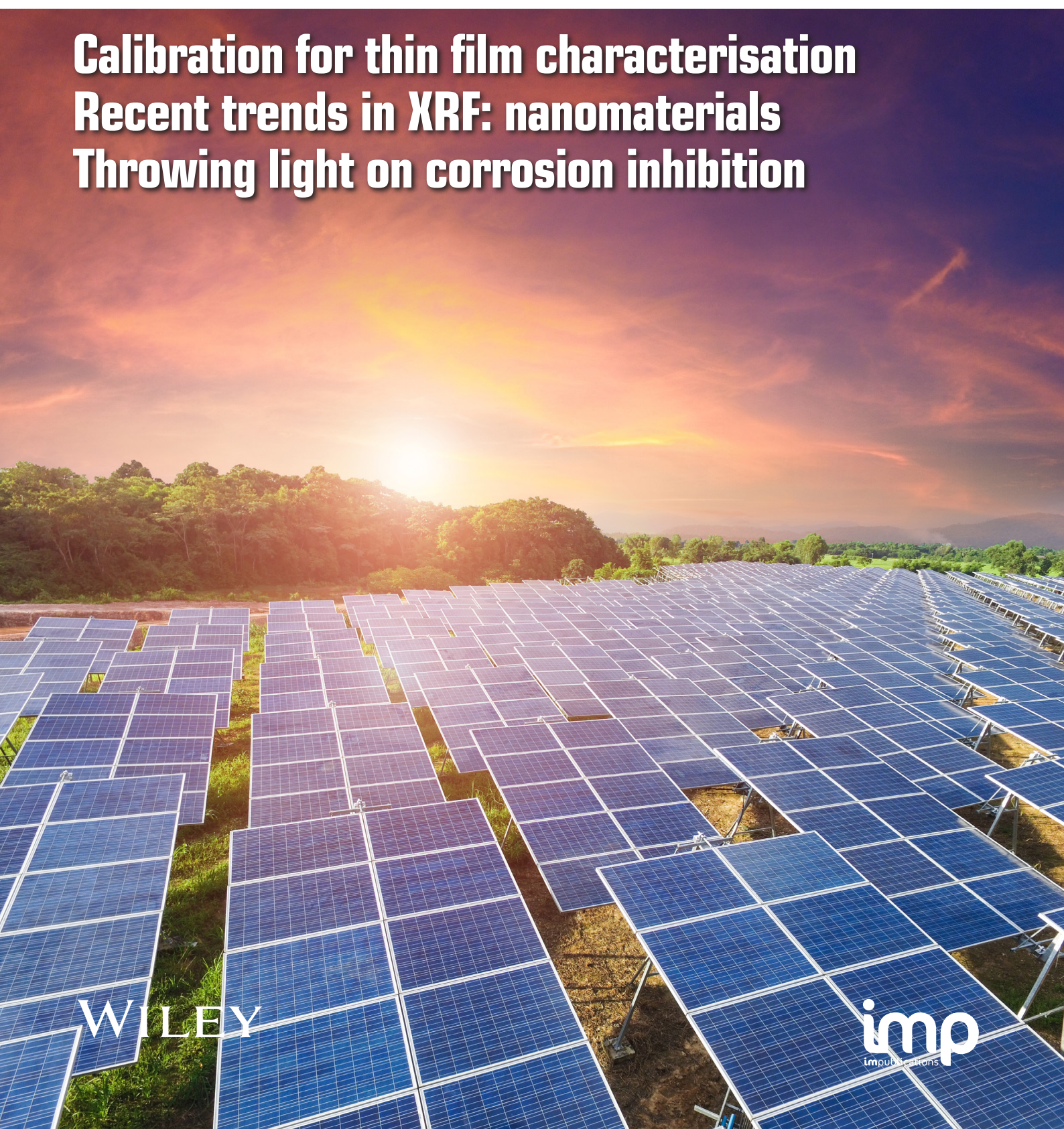

WILEY

imp
Implications

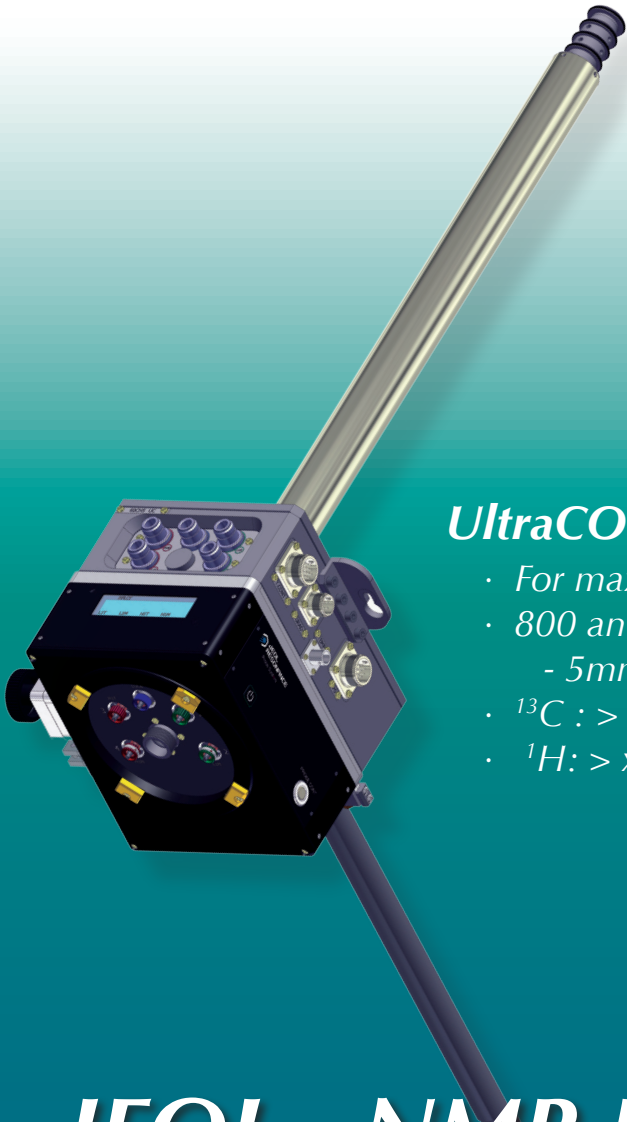

UltraCOOL Probe

- For maximum sensitivity
- 800 and 600MHz
 - 5mm C-H and H-X type
- ^{13}C : > x5 higher sensitivity
- ^1H : > x4 higher sensitivity



JEOL - NMR Probes

Advanced Technology and Performance

The SuperCOOL probe

- Low cost nitrogen cooled probe
- 400MHz 5mm tunable type
- ^{13}C : x3 higher sensitivity
- ^1H : > x3 higher sensitivity

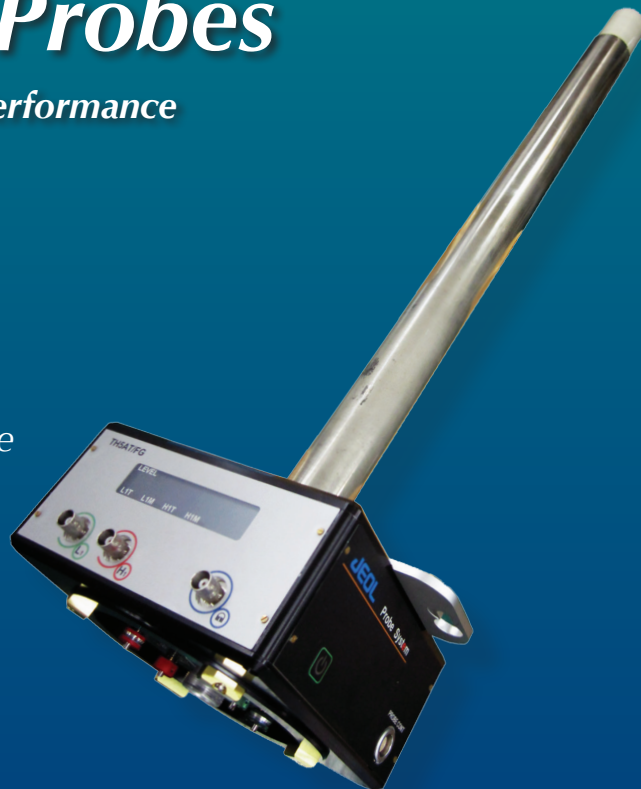

Shining a light on the past

The great spectroscopist Tomas Hirschfeld had a number of sayings attributed to him.¹ One that has always stuck in my mind is "References are very useful if relatively recent or very old". With that in mind, and prompted by a talk at the Christmas meeting of the Infrared and Raman Discussion Group, I resurrected an old project to digitise some of the material from this publication's predecessor, *European Spectroscopy News*, or *ESN* as it was commonly known.

In its early years, *ESN* published a number of interviews with eminent spectroscopists. Reading them now, over 40 years later, it seems to have been in a different age! Anyway, the first two are now available for all to read: with Sir Harold (Tommy) Thompson and Jean Lecomte. They are available on our website at <https://www.spectroscopyeurope.com/interviews>.

I plan to add the others, as time allows.

I was also prompted by another comment to realise that there is much other, valuable content we have published over the years that has become rather buried, but is worthy of highlighting. Tony (A.M.C.) Davies wrote many contributions to the Tony Davies Column on chemometrics, usually related to near infrared spectroscopy. Some of these formed series of articles, one I think is still particularly useful is "Back to basics". This group of 13 articles serves as an excellent introduction to chemometrics, and would not be wasted on the more experienced either!

Tony, and his frequent co-author Tom Fearn, have the ability to explain complex statistical concepts in simple words and diagrams. That is why these articles are so valuable. They are now collected on a single page (<https://www.spectroscopyeurope.com/back-to-basics>) and I urge

you to have a look and encourage others to do so as well.

If you have suggestions for other content, hidden or not yet digitised, that you believe deserves bringing into the light, please let me know (ian@impublishations.com) and we'll do our best!

Reference and links

1. W. Fred McClure, "Tomas Hirschfeld: A Tribute", *NIR news* 5(2), 3 (1994). doi: <https://doi.org/10.1255/nim.236>
2. *ESN* Interviews, <https://www.spectroscopyeurope.com/interviews>
3. Tony Davies Column, Back to basics series, <https://www.spectroscopyeurope.com/back-to-basics>

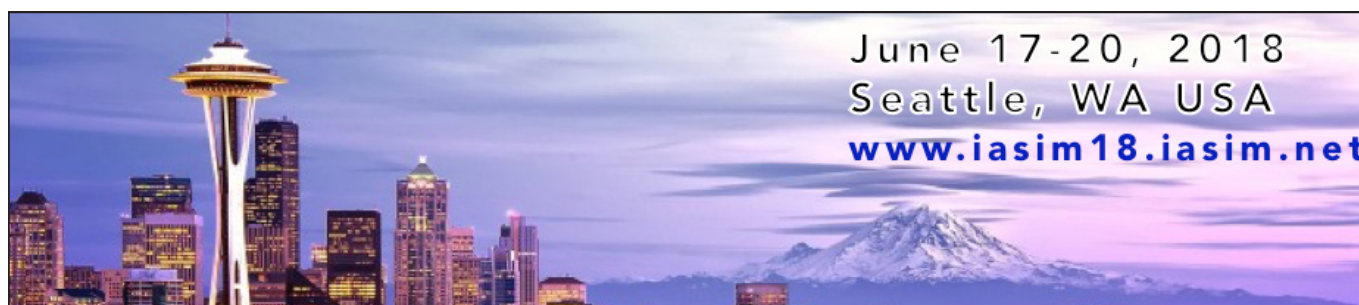

IASIM18, June, 17–20, 2018, Seattle, WA, USA

The seventh **International Association for Spectral Imaging Meeting** will be held in beautiful downtown Seattle at the Washington Athletic Club (www.wac.net). The conference embraces all aspects of spectral imaging and provides a platform for the exchange of ideas across disciplines. It also provides a vibrant forum for organizations to **exhibit and present their products and services**.

Abstract submissions for IASIM18 are now being accepted for talks and posters. Information can be found at www.iasim18.iasim.net. **Deadline: April 5, 2018.**

- Sunday afternoon **workshop** with instructors **S. Kucheryavskiy** and **J.M. Amigo Rubio**.
- Sunday opening **keynote** with a **reception** following.
- Mon–Wed **topics** include spectral imaging in microscopic, macroscopic, remote sensing, multi- / hyperspectral imaging, instrumentation, sampling, data and image processing, chemometrics and signal processing, ...
- Tuesday evening is the conference dinner.
- **Challenge problem** with prize for best solution.
- **Poster session** and **Exhibit** includes prizes for best poster and best image on a poster.
- The *Journal of Spectral Imaging* will publish a **special issue** dedicated to IASIM18.

www.iasim18.iasim.net



Thin films are important as absorber layers for high-efficiency solar cells. The article starting on page 11 explores the determination of their composition as well as their elemental depth profile (among other applications) using reference-free XRF and sputter-assisted AES.

Publisher

Ian Michael
E-mail: ian@impublishations.com

Advertising Sales UK and Ireland

Ian Michael
IM Publications, 6 Charlton Mill, Charlton,
Chichester, West Sussex PO18 0HY, United
Kingdom. Tel: +44-1243-811334,
Fax: +44-1243-811711,
E-mail: ian@impublishations.com.

Americas

Joe Tomaszewski
John Wiley & Sons Inc.
Tel: +1-908-514-0776
E: jtomaszews@wiley.com

Europe and the Rest of World

Stephen Parkes
John Wiley & Sons Ltd, The Atrium, Southern Gate,
Chichester, West Sussex PO19 8SQ, UK,
Tel: +44-1243-770367,
Fax: +44-1243-770432,
E-mail: stephen.parkes@wiley.com

Paid subscriptions

Journals Subscriptions Department, John Wiley &
Sons, Ltd, The Atrium, Southern Gate, Chichester,
West Sussex PO19 8SQ, UK.
Tel +44-1243 779777, Fax +44-1243 843232,
e-mail: cs-journals@wiley.co.uk

Spectroscopy Europe is a joint publication of
John Wiley & Sons Ltd, The Atrium, Southern
Gate, Chichester, West Sussex PO19 8SQ, UK,
and IM Publications LLP, 6 Charlton Mill, Charlton,
Chichester, West Sussex PO18 0HY, UK.

Vol. 30 No. 1
February/March 2018

ISSN 0966-0941

CONTENTS

3 Editorial

6 News

DRIFTS provides soil analysis to inform about carbon levels; Electro-mechano-optical NMR detection; NIR imaging helps improve seed QC; XRF shows danger of toxic elements in old children's toys; Raman spectroscopy in battery research; Infrared lasers reveal unprecedented details in surface scattering of methane...

11 Qualifying calibration samples for advanced thin film materials characterisation

Cornelia Streeck, Thomas Wirth, Wolfgang Unger and Burkhard Beckhoff

15 Recent trends in X-ray fluorescence spectrometry: precise investigation of nanomaterials

Manoj K. Tiwari

20 Tony Davies Column: Throwing light on corrosion inhibition

Malgorzata Kopec, Stuart B. Lyon, Brenda D. Rossenaar, Simon R. Gibbon and Antony N. Davies

23 Sampling Column: Theory of Sampling (TOS): *pro et contra*

Kim H. Esbensen and Claudia Paoletti

27 New Products

30 Diary

35 Advertisers Index

Spectroscopy Europe is a controlled circulation journal, published seven times a year and available free-of-charge to qualifying individuals in Europe. Others can subscribe at the rate of €152 (Europe), £108 (UK), \$208 (ROW, postage included) for the seven issues published in 2016. All paid subscription enquiries should be addressed to: *Spectroscopy Europe*, John Wiley & Sons Ltd, Journals Administration Department, The Atrium, Southern Gate, Chichester, West Sussex PO19 8SQ, UK.

Copyright 2018 John Wiley & Sons Ltd and IM Publications LLP

All rights reserved. No part of this publication may be reproduced, stored in a retrieval system, or transmitted, in any form or by any means, electronic, mechanical, photocopying, recording or otherwise, without the prior permission of the publisher in writing.

Printed in the UK by Warners Midland

WILEY

imp
impublishations

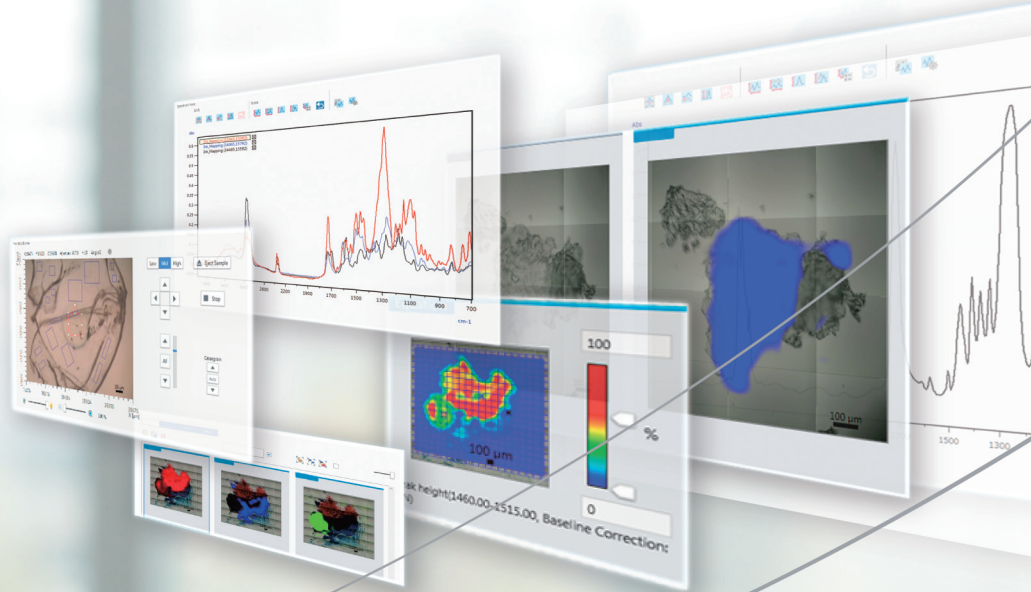

Unveiling the cause of failures

AIM-9000 Infrared Microscope System: quick and easy micro analysis

The AIM-9000 Infrared Microscope for automatic failure analysis delivers a unique concept for micro sample analysis – applicable for various industries. Its functionality is simpler and more convenient to use than ever before. A wide range of accessories complements the instrument to fully support sample observation, measurement and identification.

Highest sensitivity marketwide

with a signal-to-noise ratio of a staggering 30.000/1

Automatic zoom-in from eye-size to contaminant-size
through wide field camera feature

Automatic contaminant recognition function
sets aperture on measurement spots automatically

Automatic identification of the spectrum
through contaminant analysis program



IRTracer-100 + AIM-9000



IRAffinity-1S + AIM-9000

DRIFTS provides soil analysis to inform about carbon levels

Researchers led by Argonne National Laboratory investigated the suitability of diffuse reflectance Fourier transform mid-infrared (DRIFT) spectroscopy to discriminate variations in the physical and chemical properties of soil to improve estimates of the spatial variability of carbon stocks and the extent of organic matter decomposition in these soils. The researchers analysed archived soils collected from a 2800-km latitudinal transect across Alaska to provide a representative range of climate, vegetation, surficial geology and soil types for the region. The chemical composition of organic matter, as well as site and soil properties, exerted strong multivariate influences on the DRIFT spectra. Spectral differences indicated that soils with less decomposed organic matter contained more relatively fresh materials, such as carbohydrates and aliphatics; whereas,

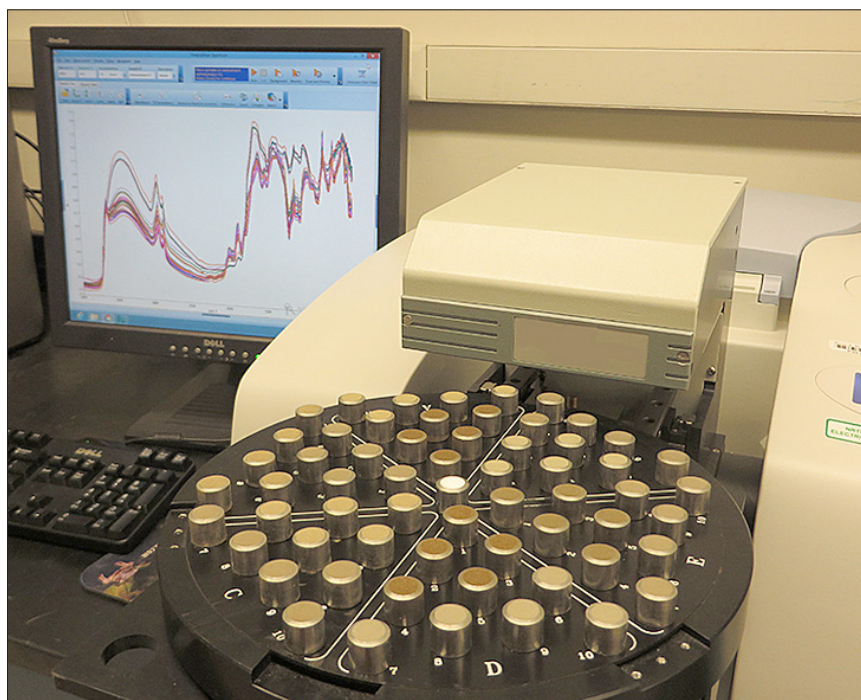

Infrared spectrometer measures organic and mineral functional groups and allows for the rapid characterisation of northern cold-region soil organic matter. Credit: Image courtesy of Roser Matamala

New accreditations for Starna

Starna has announced accreditation to the new Reference Material Producer (RMP) ISO 17034 Accreditation for its Certified Reference Materials (CRMs) for Photometry Instrument Performance Verification (IPV). Starna can support laboratories accredited to the new ISO/IEC 17025:2017, where, for the first time, there are clear and unambiguous statements in the standard that "Certified values of certified reference materials from RMPs conforming to ISO 17034 provide metrological traceability" and "RMPs fulfilling the requirements of ISO 17034 are considered to be competent".

Starna Scientific Ltd was the first laboratory to be accredited to ISO Guide 34 by UKAS, No. "4001" in 2006. They have now been successfully assessed according to the requirements of the recently published ISO 17034:2016 Standard.

Metrohm acquires Innovative Photonic Solutions

Metrohm has announced the acquisition of Innovative Photonic Solutions (IPS). IPS is the largest producer of Raman spectroscopy diode-based light components in the world. Founded in 2003, the company's products range from simple components, such as packaged diodes and OEM modules that include electronics, to complete custom-designed systems.

Metrohm already manufactures the Mira range of handheld Raman analysers, so there is good synergy between the two companies.

Spectro and Bernd Kraft announce cooperation agreement

Spectro Analytical Instruments and Bernd Kraft GmbH have announced a cooperation agreement that went into effect on 1 January 2018. As part of this agreement, every Spectro customer from Germany, Austria and Switzerland will automatically receive a starter set of certified multielement standard solutions from Bernd Kraft when purchasing a Spectro ICP spectrometer.

Record sales for Advion's single quadrupole Compact Mass Spectrometer

Advion, Inc. has announced that, during the year ending 31 December 2017, it reached several major milestones. They sold 58 Compact Mass Spectrometer (CMS) units per quarter and approached 750 CMS units shipped, with the 700th order having been received from Japan. Nearly 30 CMS units were sold in Japan during 2017. Direct sales and support operations in China contributed 9 unit sales in Q4 2017.

Commenting on the landmarks, Advion's CEO David B. Patteson stated, "Having launched the expression CMS product line about four years ago, we are exceedingly happy with the market adoption and product adaptation. In 2012–2013, we quickly realised 10 units per quarter, and in 2017 approached 60 per quarter."

clays and silicates were incorporated into more degraded soils. The team identified a single spectral band that might be used to quickly estimate soil organic carbon and total nitrogen concentrations. Overall, the study demonstrated that DRIFT spectroscopy can serve as a valuable tool for quickly and reliably assessing variations in the amount and composition of organic matter in northern cold-region soils.

Funding

This study was supported by the US Department of Energy, Office of Science, Office of Biological and Environmental Research, Climate and Environmental Science Division, Terrestrial Ecosystem Science Program under contract DE-AC02-06CH11357 to Argonne National Laboratory. F. Calderón was supported by the US Department of Agriculture, Agricultural Research Service.

Reference

R. Matamala, F.J. Calderón, J.D. Jastrow, Z. Fan, S.M. Hofmann, G.J. Michaelson, U. Mishra and C.L. Ping, "Influence of site and soil properties on the DRIFT spectra of northern cold-region soils", *Geoderma* 305, 80–91 (2017). doi: <https://doi.org/10.1016/j.geoderma.2017.05.014>

Electro-mechano-optical NMR detection

An international research project led by Kazuyuki Takeda of Kyoto University and Koji Usami of the University of Tokyo has developed a new method of light detection for nuclear magnetic resonance (NMR) by up-converting NMR radio-frequency signals into optical signals. This new detection method has the potential to provide more sensitive analysis compared with conventional NMR. Its possible utilisation in higher-accuracy chemical analysis, as well as in magnetic resonance imaging (MRI) technology, are also of interest.

"NMR is a very powerful tool, but its measurements rely on amplification of electrical signals at radio-frequencies. That pulls in extra noise and limits the sensitivity of our measurements", explains Dr Takeda. "So we developed an experimental NMR system from scratch,

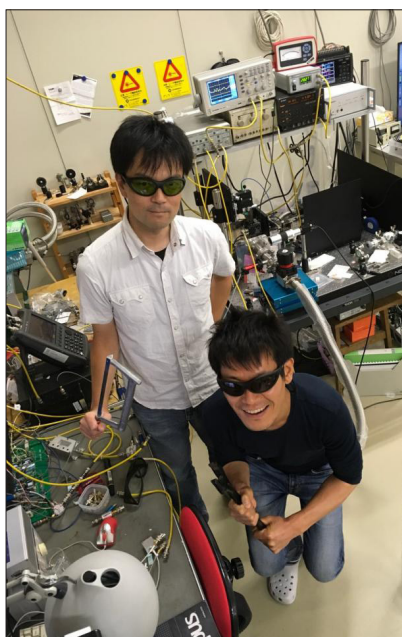

Dr Kazuyuki Takeda (left) and Dr Koji Usami (right) with their experimental system. Credit: Kyoto University / Kazuyuki Takeda

which converts radio-frequency signals into optical ones."

The principle behind this "up-conversion" is a new hybrid quantum conversion technology. The team worked to integrate this system into NMR, eventually building a device that connects electronics to mechanics, and then to optics. The material linking all three systems is an elastic membrane of silicon nitride.

"We constructed a capacitor by vacuum-depositing a metal layer onto the silicon nitride membrane", explains co-author Dr Usami. Using this with an inductor, they built a resonator to detect NMR signals, and next constructed an optical cavity using the metal layer as a mirror. "The incoming electric NMR signal shakes the membrane, causing motion that is detected by an optical interferometer."

The team believes that the success of this optical detection can push the





XXII International Mass Spectrometry Conference
August 26 - 31, 2018

LIFE SCIENCES
 INSTRUMENTATION AND METHODS
 ORGANIC AND INORGANIC MS
 FOOD AND BEVERAGE
 FUNDAMENTALS

SHORT COURSES
 ORAL PRESENTATIONS
 POSTER PROGRAM
 WORKSHOPS
 EXHIBITION

www.imsc2018.it

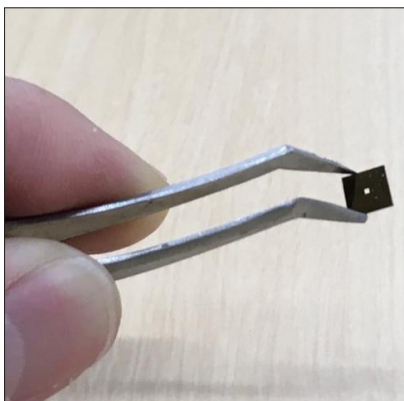

This is the material linking the three electro-mechano-optical systems. Credit: Kyoto University / Kazuyuki Takeda

spectroscopy method even further, with the hope that this increased accuracy in detection and characterisation of materials can be utilised in multiple scientific disciplines.

Kazuyuki Takeda concludes, "Various methods for optical NMR detection have been reported, and while some are highly sensitive, they have so far lacked widespread applicability. Our new scheme has proven to be both versatile and applicable to a wide range of materials."

The work has been published in *Optica* (doi: <https://doi.org/10.1364/OPTICA.5.000152>).

NIR imaging helps improve seed QC

The Winter 2017/2018 edition of *CRA-W Info*, the newsletter of the Wallon Agricultural Research Center, reports on the use of near infrared (NIR) hyperspectral imaging for the control of the addition of chemicals to seeds. The treatment of seeds with plant protection products is strongly recommended to fight different plant diseases and pests in the early stages of plant growth, but which analytical methods are available to control the dose and homogeneity of the treatment on a seed lot?

New seed treatment products are effective at very low doses, and effective treatment requires the application of the active ingredient at the correct dose according to the species, the variety and the health status of the lots. Too low a

dose may lead to insufficient protection of the plant, while too high a dose could increase the risk of phytotoxicity. Further, the active ingredient must be evenly distributed not only between the seeds in a lot but also on the surface of the seeds, including the groove.

The reference methods used to control the quality of seed treatment are chromatographic methods, which are time-consuming, costly, destructive and difficult to use in routine controls. NIR spectroscopy does not have these problems and can be used to identify the active ingredients and their average dosage on a seed lot or individual seeds with adapted sample presentation devices. Near infrared hyperspectral imaging allows the analysis of several seeds simultaneously while assessing the dose and homogeneity of the treatment on each seed. A study carried out by Pauline Flémal (Université catholique de Louvain, Belgium) within the framework of her thesis, revealed the potential of this technology combined with chemometrics to control the quality of seed treatment.

The results of the analysis of treated seeds on an average dosage by UHPLC and NIR spectroscopy showed a high level of variability between lots treated

with the same formulation, from different seed producers. Regarding barley, the active ingredient content in 85% of samples was less than 70% of the target dose.

Thanks to NIR hyperspectral imaging, it was also possible to detect the potential presence of seeds from another species/variety in a seed lot, untreated seeds or seeds treated with a different formulation. It was also possible to assess the homogeneity of the treatment on each seed individually and to classify them according to the target dose. For some lots, the active ingredient content in more than 75% of the seeds was higher than the acceptable 30% around the target dose.

This technology opens up new opportunities in terms of seed quality control. This study was published in the *Journal of Spectral Imaging* (doi: <https://doi.org/10.1255/jsi.2017.a1>).

XRF shows danger of toxic elements in old children's toys

Scientists from the University of Plymouth have used X-ray fluorescence (XRF) spectrometry to analyse 200 used plastic toys which they found in homes, nurseries and charity shops across the

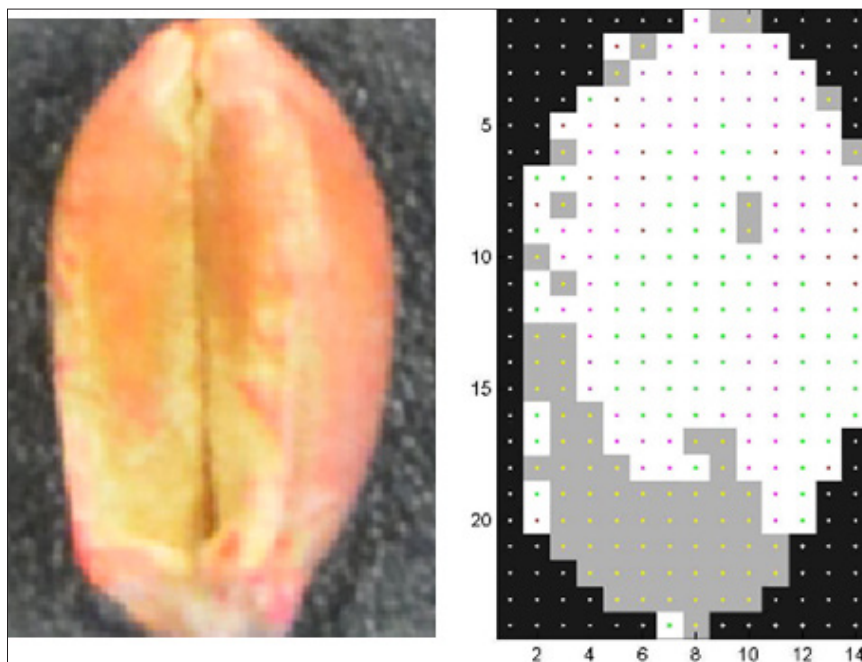

Visible image and predictive hyperspectral image of a wheat seed showing the treated area in white and the non-treated area in grey.



Second-hand plastic toys may contain high concentrations of hazardous elements.

south-west of the UK. These included cars, trains, construction products, figures and puzzles, with all of them being of a size that could be chewed by young children. They discovered high concentrations of hazardous elements including antimony, barium, bromine, cadmium, chromium, lead and selenium—which are chronically toxic to children at low levels over an extended period of time—in many building blocks, figures and items of jewellery that were typically either yellow, red or black.

Further tests showed that under simulated stomach conditions (involving extraction in dilute hydrochloric acid) several toys released quantities of bromine, cadmium or lead that exceeded limits set by the European Council's Toy Safety Directive, with the release of cadmium exceeding its limit value by an order of magnitude in some cases.

The research was led by Dr Andrew Turner, who used XRF spectrometry to analyse the presence of elements within individual toys. He has previously conducted research which showed that decorated drinking glasses can contain harmful levels of lead and cadmium (see <http://bit.ly/2EOZRcr>), and that play-ground paints should be more closely monitored to reduce potential danger to public health.

Dr Turner said: "This is the first systematic investigation of hazardous elements in second-hand plastic toys in the UK. Second-hand toys are an attractive option to families because they can be inherited directly from friends or relatives or obtained cheaply and readily from charity stores, flea markets and the internet. But while the Toy Safety Directive applies to new products there is no regulation covering the recycling or re-sale of older toys. With the introduction and refinement of the Toy Safety Directive, the plastics industry has had to take steps to eliminate hazardous elements from new toys. However, consumers should be made more aware of the potential risks associated with small, mouthable and brightly coloured old plastic toys or components. Without that, the attractive cost, convenience and recyclability of previously used toys has the potential to create a legacy of chemical contamination for younger children."

The full study was published in *Environmental Science and Technology* (doi: <https://doi.org/10.1021/acs.est.7b04685>).

Raman spectroscopy in battery research

Power generation is shifting from traditional to less predictable renewable sources. Consumers are demanding faster

Certified Reference Materials for Instrument Qualification

The widest range:

Deep UV to Infra-red

Up to 3.5 Absorbance

NIST Traceable

ISO 17034 Reference Material Producer

ISO/IEC 17025 accredited supplier

Lifetime Guarantee

Fast Recalibration Service

Meet all International regulatory Standards

See us at
PITCON
Booth 2654



Starna

Starna Scientific Ltd

www.starna.com
+44 (0) 20 8501 5550

sales@starna.com

charging and longer battery life for their products. Both trends require the development of better energy storage devices.

The Stephenson Institute for Renewable Energy, part of the Department of Chemistry, University of Liverpool, UK, is developing these devices, in the form of batteries and supercapacitors. Key to this work is understanding the interfacial processes that occur at electrode surfaces. The team, headed by Professor Laurence Hardwick, is investigating the reaction mechanisms that lead to surface layer formation and identifying the species that form these layers. It is vital to understand these since they influence the performance and safety of both metal-air and lithium-ion batteries.

Professor Hardwick's group uses a range of *in situ* analytical techniques in their studies: infrared (IR) spectroscopy, X-ray photoelectron spectroscopy (XPS), UV/vis and Raman spectroscopy. Each technique has its advantages. IR spectroscopy allows them to investigate the mechanisms that lead to electrolyte decomposition during attack by the superoxide species formed during oxygen reduction in lithium-air batteries. They use XPS to study the chemical elements present in the top few nanometres of the electrode surfaces, their quantities and oxidation state. They determine the electronic state of reduced oxygen species, which can adversely affect device stability, with UV/vis spectroscopy.

Raman spectroscopy is a particularly powerful technique for this application. Hardwick's group uses a Renishaw inVia confocal Raman microscope for this work. They can study the electrode through the electrolyte, with a high spatial resolution, with high sensitivity and non-destructively. The inverted microscope configuration of their instrument makes it easy to analyse working electrochemical cells (operando measurements), where they can identify intermediate species in reactions and study phase changes. They also get valuable information from *ex situ* Raman mapping measurements. For example, they identify the different discharge products produced on cathodes, and determine their distribution.

This work has helped the team to get a better understanding of the oxygen reduction reaction (ORR) and oxygen evolution reaction (OER) mechanisms, and the intermediary species that are formed. They use surface enhanced Raman scattering to amplify the electrode surface spectra, whilst electrochemically cycling the cells. This has enabled them to look at Li-ion and Na-ion cells having electrodes ranging from graphite and graphene to carbon-coated oxides.

Further details of the group's publications can be found at <https://www.liverpool.ac.uk/chemistry/staff/laurence-hardwick/publications/>.

Infrared lasers reveal unprecedented details in surface scattering of methane

When molecules interact with solid surfaces, a whole range of different dynamic processes can take place. These are of enormous interest in the context of catalytic reactions, e.g. the conversion of natural gas into hydrogen that can then be used to generate clean electricity. Specifically, the interaction of methane molecules with a catalyst surface such as nickel is of interest if we are to gain a detailed and meaningful understanding of the process on a molecular level. But studying scattering dynamics of polyatomic molecules such as methane has been challenging because current detection techniques are unable to resolve all the

quantum states of the scattered molecules.

The lab of Rainer Beck at EPFL, Switzerland, has now used novel infrared laser techniques to study methane scattering on a nickel surface for the first time with full quantum-state resolution. Quantum-state resolved techniques have contributed much to our understanding of surface-scattering dynamics, but the innovation here was that the EPFL team was able to extend such studies to methane by combining infrared lasers with a cryogenic bolometer: a highly sensitive heat detector cooled to 1.8 K that can pick up the kinetic and internal energy of the incoming methane molecules.

In their experiments, a powerful infrared laser first pumps the incident methane molecules into a single selected, vibrationally excited quantum state. A second laser combined with the bolometer is then used to analyse the quantum state distribution of the scattered molecules. With this approach, the scientists observed, for the first time, a highly efficient mechanism for vibrational energy redistribution during surface scattering.

The data from the study will allow state-of-the-art quantum theories for molecule/surface scattering to be tested stringently. Meanwhile, the new laser tagging technique introduced in this work is widely applicable and can be used to study many other polyatomic molecule/surface systems with unprecedented detail. The work has been reported in *Physical Review Letters* (doi: <https://doi.org/10.1103/PhysRevLett.120.053402>).

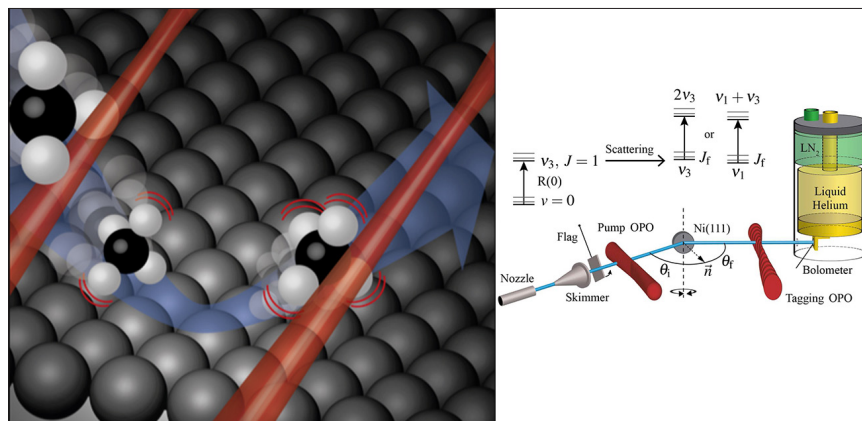

Illustration of methane scattering from a Ni(111) surface (left) and a diagram of the experimental setup used in this study (right). Credit: Rainer Beck/EPFL

Qualifying calibration samples for advanced thin film materials characterisation

Cornelia Streeck,^a Thomas Wirth,^b Wolfgang Unger^b and Burkhard Beckhoff^a

^aPTB—Physikalisch-Technische Bundesanstalt, Abbestr. 2–12, 10587 Berlin, Germany. E-mail: cornelia.streeck@ptb.de

^bBAM—Bundesanstalt für Materialforschung und -prüfung, Unter den Eichen 87, 12205 Berlin, Germany

In this article the question of the certification of calibration samples for the characterisation of advanced thin film materials is addressed within the framework of reliable process control or quality management purposes. Reference measurement techniques can be used in order to address the gap in appropriate certified reference materials (CRMs) for thin film analyses. They allow for qualifying out-of-production samples originating from an operating production line as calibration samples. As a template for this procedure, CIGS [Cu(In,Ga)Se₂] layers, that are absorber layers for high efficiency thin-film solar cells, have been used for establishing and validating reference-free X-ray fluorescence (XRF) analysis and Auger-electron spectroscopy (AES) as reference measurement techniques. The focus was on determining the average mole fractions in the CIGS layers obtaining results traceable to the SI unit system. Reference-free XRF is physically traceable and is based upon radiometrically calibrated instrumentation and knowledge of atomic fundamental data. Sputter-assisted AES can be established as a chemically traceable method after careful calibration using a certified reference material (CRM) based on a total number counting method.

Introduction

To address the challenges associated with energy generation, storage and transfer in the 21st century, innovations in the field of advanced thin film materials need to be transferred as directly as possible into the production process to ensure a fast lane of technological developments. Complex thin films have to be accurately manufactured with respect to their spatial and elemental composition, interface properties and thicknesses. The reliable analyses of these properties is important in the development and production of advanced thin films and is primarily based on dedicated calibration samples being used in the laboratory, in-line or on-line process control.

In general, a prerequisite for an appropriate calibration of complex samples is the similarity of the spatial and elemental structure of the calibration sample to the samples to be analysed. With increasing deviations of the sample composition or thickness between both, an increasing difference between the analytical values derived and the true values are induced due to non-linear matrix effects associ-

ated, for example, with (X-ray) absorption, secondary enhancement effects by electrons or characteristic photons or sputtering rate variations. The limited number of available CRMs that can be used as calibration samples for thin film analyses at the nanometre and micrometre scale means there is an important gap in the growing market for novel thin film materials.

In general, calibration samples have the role of an independent reference with respect to the location, measuring device and environment. They globally ensure the reliability and reproducibility of measuring results. Furthermore, CRMs for calibration enable the adherence of strict tolerance limits to improve the profitability of production processes. An important point in quality management systems that meet the requirements of ISO/IEC 17025 is the traceability of routine test results and their validation. This can be achieved by using known calibration samples, e.g. CRMs (chemical traceability), in addition to Round Robin activities for validation purposes. An alternate route is offered by first prin-

cipl methods that are directly traceable to the measurement units of the SI (physical traceability). Both physical and chemical traceability is considered to be equivalent. Reference-free X-ray fluorescence (XRF) and sputter-assisted Auger-electron spectroscopy (AES) were established for the application of different traceability chains.

Advanced thin film material CIGS

CIGS layers can be considered as a suitable example for a class of thin films that are already in the industrial production processes; but where no appropriate CRMs are available for reliable process control or quality management purposes. CIGS is an abbreviation for the elements present in the layers: copper Cu, indium In, gallium Ga and selenium Se (or sulfur S). The CIGS layers are used as absorber layers for thin film solar cells where their functionality is defined by their spatial and elemental composition. In Figure 1, a typical structure of such a solar cell is depicted. The approximate 2µm thick layers can reach energy conversion effi-

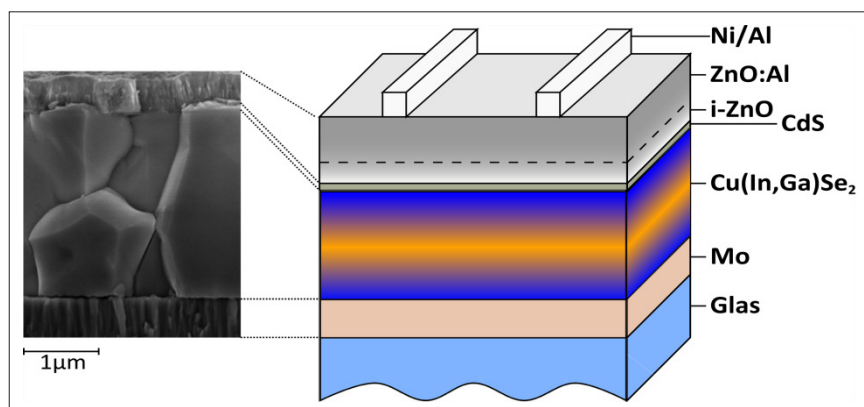

Figure 1. Illustration of a thin film solar cell based on a CIGS [Cu(In,Ga)Se₂] absorber layer. On a substrate (e.g. glass) a molybdenum (Mo) layer is used as back contact. The p-type CIGS layer forms the pn-junction with the n-type buffer layer (CdS) and the n-type window layer (ZnO:Al). The photo current can be collected with a metallic grid on top (Ni/Al).

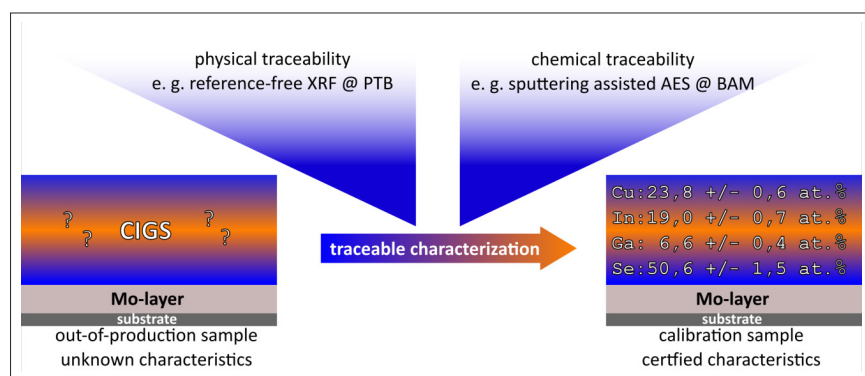

Figure 2. The scheme illustrates the certification of a typical out-of-production sample, here as an example, a CIGS-layer on a molybdenum coated substrate, to a traceable sample for calibration of methods used for in-line analysis at production facilities. The reference measurement methods can be based either on physical or chemical traceability chains.

ciencies over 20%, playing in the same league as multicrystalline Si.¹ Both the average composition of the overall CIGS layer and the elemental depth profile of CIGS absorber layers are major factors for determining the conversion efficiency of the solar cell.

One challenge posed by this sample system is the analytical question of determination of the in-depth elemental gradient. A detailed study on this topic has been published by Abou-Ras,^{2,3} demonstrating that several methods reveal comparable results within their given uncertainties for the measured gradient, while other methods differ significantly, thus leaving the question of the “true” in-depth gradient somewhat unanswered. The analytical objective of the average composition of the

CIGS-layer was addressed as a priority. At PTB, the National Metrology Institute of Germany, and BAM, the German Federal Institute for Materials Research and Testing, reference-free XRF analysis and sputter-assisted AES were set up as traceable measurement capabilities for the characterisation of CIGS layers (see Figure 2).

Reference-free X-ray fluorescence analysis

Conventional XRF analysis is well suited to thin film analysis. About 25% of the world-wide XRF market volume is correlated to analytics of thin layers and coatings. With XRF, the mass deposition of elements can be non-destructively determined. Knowing the density of the thin film, the layer thickness can be calcu-

lated, too. The employed XRF devices are quite variable with respect to their size, beam geometry or automation. For conventional quantification, as used on XRF instruments in field laboratories in industrial or scientific applications, they have to rely on a calibration procedure, which is most appropriate when using a dedicated calibration sample similar to the layer to be analysed. The reliability of analytical results here can be considerably improved when using certified thin film calibration samples. Reference-free XRF is a powerful tool for certification of such calibration samples.

The approach of reference-free XRF enables an advanced quantification without the need for any calibration samples. This method is physically traceable to the SI unit for the amount of substance, the mol. It uses well-defined monochromatic radiation, radiometrically calibrated instrumentation and knowledge on atomic fundamental parameters such as interaction cross-sections and fluorescence yields⁴ (see Figure 3). The measured count rates of characteristic XRF lines per incident radiation intensity from a thin film sample are translated into a mass deposition of the corresponding elements in the film on the substrate.⁴

A typical XRF spectrum of a CIGS thin film sample for an excitation energy of 11 keV and a calibrated energy-dispersive silicon drift detector (SDD) is shown in Figure 4. The deconvolution of the spectrum is based upon both detector response functions and physical models for background contributions such as X-ray resonant Raman scattering or bremsstrahlung.

Quantification is based on a least-square algorithm fitting measured and calculated fluorescence line intensities. The average composition can be determined by using the typical, standard 45° XRF geometry, for both the angle of incidence and detection. Even the in-depth elemental gradient of a CIGS layer is accessible by using a set of angles of incidence from the shallow grazing incidence regime beginning at about 0.2° up to 45° and fitting the parameters of an appropriate elemental in-depth profile.⁵

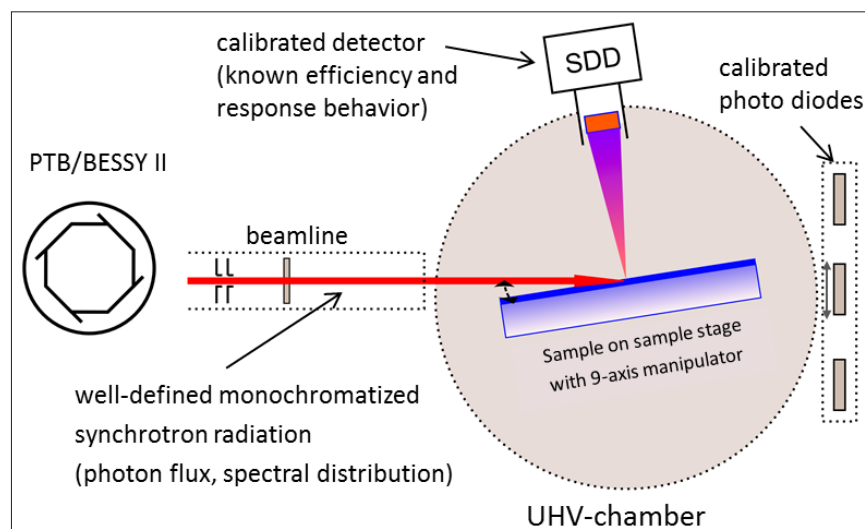

Figure 3. Scheme of reference-free XRF. For XRF spectrometry, monochromatised synchrotron radiation from the soft to hard X-ray range can be used. A solid state detector (SDD) is typically used as the X-ray detector.

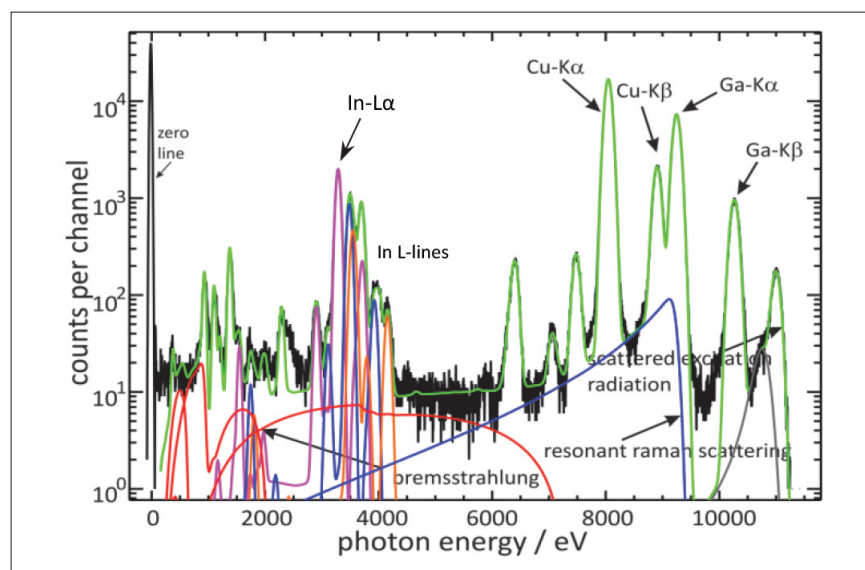

Figure 4. XRF spectrum for a CIGS thin film sample measured at PTB in the synchrotron radiation facility BESSY II for certification of the integral film composition. Cu-K α , Ga-K α and In-L α fluorescence line intensities were used.

Sputter-assisted in-depth analysis by Auger electron spectroscopy

AES is often used for chemical and compositional analysis of technical surfaces. Due to the small inelastic mean free path of the electron beam induced Auger electrons in the material, the information depth of AES is within few atomic layers. For an analysis of overlayers up to thicknesses of some μm , AES can be combined with argon ion sputtering, enabling elemental in-depth analysis.

At BAM, a PHI 700 Scanning Auger Probe (ULVAC-PHI Inc.) equipped with a cylindrical mirror analyser is used for thin film analysis. Depth profiling was carried out by sequential 3 keV Ar⁺ ion sputtering. A typical AES survey spectrum of CIGS is shown in Figure 5 together with depth profiles of the elements. For excitation of the CIGS surface layer, a primary electron beam of 5 keV was used.

The intensity scale of Figure 5 can be expressed in composition data (at.%) when a calibration sample is available.

Because CIGS is a quaternary crystalline material, substantial matrix effects in AES have to be expected. Therefore, the composition of such a reference material must be very similar to that of the sample to be measured. The use of a reference material which is certified in a way that its composition is traceable to the SI unit of the amount of substance (mol) would make, by careful calibration, AES a traceable method, too. Options to certify CIGS as reference material are, e.g., ID ICP-MS (isotope dilution inductively coupled plasma mass spectrometry) or reference-free XRF. For layers where the constituents are homogeneously distributed in depth for both the reference material and the sample to be analysed, quantification is enabled by individual elemental sensitivity factors. For CIGS layers with the typical variation of in-depth elemental composition, a quantification of the average composition can be accomplished by a total number counting method. This method is based on measuring the integrated intensity of a constituent element in a depth profile of a similar CRM and a calculation of respective sensitivity factors.⁶ The signal intensities of the constituent elements are determined from the summation of the individual intensities over all measurement cycles by using either the peak areas or the peak-to-peak heights. This method relies on a CRM and was recently validated by an inter-laboratory comparison organised by an international working group of the International Meter Convention.⁶

International inter-laboratory key-comparison for CIGS thin films

Both methods, reference-free XRF and sputter-assisted AES with a total number counting method, were part of that key comparison with the objective to compare the equivalency of participating institutes for measuring the average mole fractions of Cu, In, Ga and Se in an approximately 2 μm thin CIGS film.⁶ The main focus was on sputter-assisted methods. In addition to AES, X-ray photoelectron spectroscopy (XPS) and secondary ion mass spectrometry (SIMS) were also used to determine the average composition of a CIGS thin

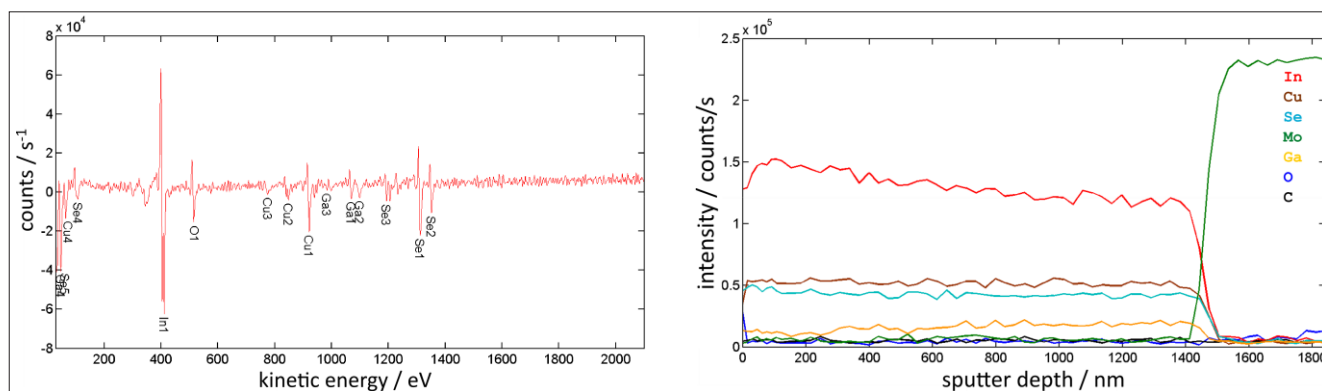

Figure 5. Left: AES spectrum of a CIGS surface after removal of surface oxides and contamination by Ar^+ sputtering. Elements are identified by the characteristic kinetic energy of Auger electrons. For the determination of the composition, the Auger transitions Cu LMM (922 eV), In MNN (405 eV), Ga LMM (1070 eV) and Se LMM (1311 eV) are used. Right: elemental depth profile across the CIGS film sample down to the Mo substrate. See text for further details.

film by using the total number counting method and a certified sample for calibration. This sample was certified by ID-ICPMS.⁷ Although AES, XPS and SIMS are not traceable measurement methods on their own, the key comparison has shown that after careful calibration with a certified reference material, traceability is reached. The only method included in the key comparison which does not need the reference sample is reference-free XRF, because it is a primary method with intrinsic traceability.

Summary and outlook

By using reference-free XRF, a primary method with traceability to the SI units mol and metre, determination of the mass deposition of layered samples is possible. The method allows for the determination of average mole fraction and thickness of the layer. Thus, out-of-production samples, exemplarily shown here on a CIGS thin film layer, can be certified as calibration samples for process control by field XRF instruments and other methods like AES, SIMS and XPS. In this way these methods become traceable. Such traceability promotes the value of these methods in quality management systems in test laboratories working under ISO/ICE 17025 accreditation. Moreover, for selected sample

systems it could be shown that this XRF methodology is enabling a determination of elemental in-depth gradients.⁵ However, higher measurement and data reduction efforts are required to reach this goal. The given approach to certify an out-of-production sample in a way traceable to the SI is not limited to CIGS but can also be extended to other types of thin-film sample systems at the nanometre or micrometre scales. Reference methodologies, such as reference-free XRF and calibrated AES, can meet the growing demand on well-characterised thin film samples.

With respect to XRF analysis, a widely used technique in testing laboratories engaged in thin-film analysis, standardisation under ISO/TC 201/SC10 is on-going. The aim is here to establish an ISO standard for the certification of out-of-production samples for thin film analyses by traceably calibrated commercial XRF instruments.

References

1. M.A. Green, Y. Hishikawa, W. Warta, E.D. Dunlop, D.H. Levi, J. Hohl-Ebinger and A.W.H. Ho-Baillie. "Solar cell efficiency tables (Version 50)", *Prog. Photovoltaics: Res. Appl.* **25**(7), 668 (2017). doi: <https://doi.org/10.1002/pip.2909>
2. D. Abou-Ras, R. Caballero, C.-H. Fischer, C.A. Kaufmann, I. Lauermann, R. Mainz, H. Mönig, A. Schöpke, C. Stephan, C. Streeck

et al., "Comprehensive comparison of various techniques for the analysis of elemental distributions in thin films", *Microsc. Microanal.* **17**(5), 728 (2011). doi: <https://doi.org/10.1017/S1431927611000523>

3. D. Abou-Ras, R. Caballero, C. Streeck, B. Beckhoff, J.-H. In and S. Jeong, "Comprehensive comparison of various techniques for the analysis of elemental distributions in thin films: additional techniques", *Microsc. Microanal.* **21**(6), 1644 (2015). doi: <https://doi.org/10.1017/S1431927615015093>
4. B. Beckhoff, "Reference-free X-ray spectrometry based on metrology using synchrotron radiation", *J. Anal. At. Spectrom.* **23**(6), 845 (2008). doi: <https://doi.org/10.1039/b718355k>
5. C. Streeck, S. Brunken, M. Gerlach, C. Herzog, P. Hönicke, C.A. Kaufmann, J. Lubeck, B. Pollakowski, R. Unterumsberger, A. Weber, B. Beckhoff, B. Kanngießner, H.-W. Schock and R. Mainz, "Grazing-incidence x-ray fluorescence analysis for non-destructive determination of In and Ga depth profiles in Cu (In,Ga)Se₂ absorber films", *Appl. Phys. Lett.* **103**(11), 113904 (2013). doi: <https://doi.org/10.1063/1.4821267>
6. K.J. Kim, A.S. Kim, J.S. Jang, J.K. Suh, T. Wirth, W. Unger, V.-D. Hodoroaba *et al.*, "Final report of CCQM-K129 'Measurement of Mole Fractions of Cu, In, Ga and Se in Cu(In,Ga)Se₂ Films'", *Metrologia* **53**(1A), 08011 (2016). doi: <https://doi.org/10.1088/0026-1394/53/1A/08011>
7. J.S. Jang, H.H. Hwang, H.J. Kang, J.K. Suh, H.S. Min, M.S. Han, K.H. Cho *et al.*, "Quantitative analysis of Cu(In,Ga)Se₂ thin films by secondary ion mass spectrometry using a total number counting method", *Metrologia* **49**(4), 522 (2012). doi: <https://doi.org/10.1088/0026-1394/49/4/522>

Recent trends in X-ray fluorescence spectrometry: precise investigation of nanomaterials

Manoj K. Tiwari

Synchrotrons Utilization Section, Raja Ramanna Centre for Advanced Technology, Indore 452013, Madhya Pradesh, India. E-mail: mktiwari@rrcat.gov.in

Introduction

Nanomaterials find widespread applications in many fields of science and nanotechnology, especially as catalysts in the chemical, bio-nanotechnology, nano-electronics and pharmaceutical industries. Understanding the physical and chemical properties of nanoscale materials is important, not only because of the fascinating nature of the subject, but also due to their potential applicability in almost every branch of science and technology. Nanostructured materials offer interesting properties, because at the atomic or molecular scale, the physical properties of a material become size dependent due to the quantum confinement and surface states effects.

Similarly, patterned nanostructures are very important in fabricating novel electronic, magnetic and photonic devices. For example, molecular printing of nanoparticles is highlighted as a method for creating an organised precursor structure on a substrate surface for locating nanowires and carbon nanotubes. In all the examples, the ability to control the particle size distribution and surface morphology of the nanoparticles is of crucial importance, both from the point of view of fundamental understanding and of the tremendous number of high-tech industrial applications in the areas of dye-sensitised solar cells, smart displays and glass windows, chemical, gas and bio sensors, lithium batteries, super capacitors etc.¹⁻³

Some common X-ray techniques used for nanomaterials characterisation

X-ray reflectivity

X-ray reflectivity (XRR) is a widely used characterisation technique to obtain micro-structural details of a nanostructured thin film medium (e.g. thickness, interface roughness, density variation etc). The technique offers high accuracy for the determination of the thickness of a thin medium. The XRR technique, however, has the limitation that it does not provide any element-specific information. In addition, the technique suffers from a serious limitation in its applicability to analyse ultrathin layers of thickness in the sub-nanometre range, or structures of very large thickness (>100 nm), as well as non-reflecting thin film systems.⁴

X-ray fluorescence

X-ray fluorescence (XRF) spectroscopy is one of the simplest and most widely used techniques for the non-destructive multielement analysis of materials. Over the past several years the technique has seen a remarkable progress and proved its applicability to a variety of fields such as archaeology, environment, geology and materials science.⁵ Apart from the research applications, the technique has also found success in industry, especially in maintaining the quality of ultra-pure

grade chemicals, reagents and products. In conventional XRF, the element detection sensitivities are largely limited to the $\mu\text{g g}^{-1}$ (ppm) range; mainly because of the large spectral background produced by the Compton scattered X-rays from the specimen.

Total reflection X-ray fluorescence (TXRF)

TXRF is another variant of the XRF technique, where the complexity of the Compton spectral background is eliminated to a great extent. This is due to the high reflectivity of the flat surface and low penetration depth of the primary X-ray beam in the substrate material, on which the incident X-rays are allowed to impinge at glancing incidence angles. All these features improve the detection sensitivities of TXRF technique by two or three orders of magnitude or better compared to conventional XRF: typically in the range of parts per billion (ppb) for most elements.⁶

Grazing incidence X-ray fluorescence (GIXRF)

One of the variants of TXRF, often referred as fluorescence-assisted X-ray standing wave (XSW) is a powerful and versatile tool to unfold depth-resolved physical and chemical properties of nanostructured materials, as it combines the features of both X-ray reflectivity (XRR) and XRF techniques. Under the condition of total external reflection

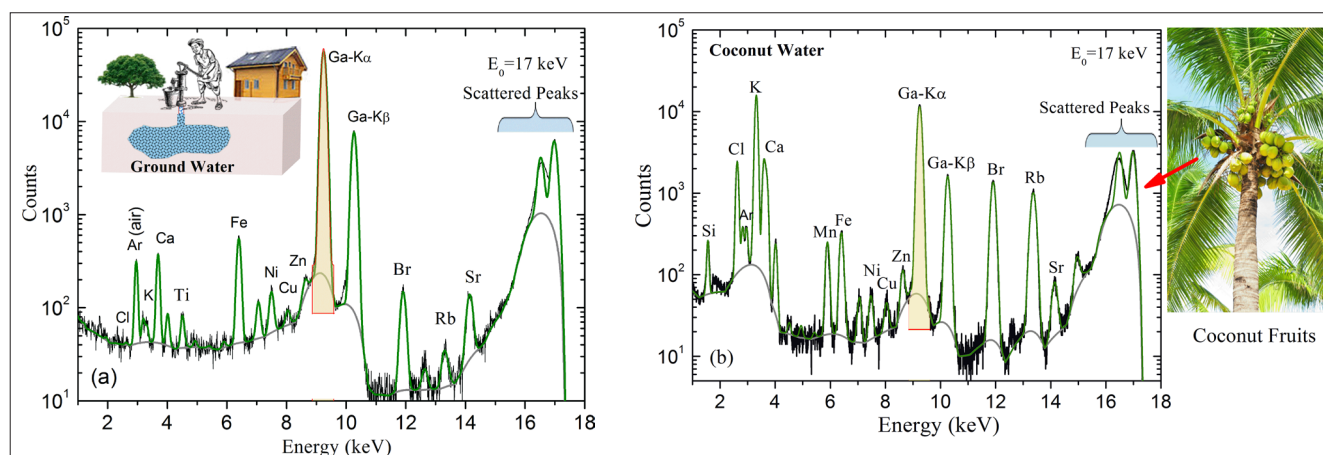

Figure 1. Measured TXRF spectrum of ground water (a) and coconut fruit water (b) at monochromatic X-ray energy of $E_0 = 17$ keV. Ga (35 ppm) was used as an internal standard during TXRF quantification. Solid back and green lines, respectively, are the experimental and fitted data whereas grey line represents a good estimation of the spectral background.

of X-rays on a mirror surface or Bragg reflection from a multilayer structure, the incoming and reflected beams interfere and form an XSW field on top of the mirror surface. This XSW field also extends below the mirror surface to a certain depth. It can be used to excite impurity elements that are embedded inside a thin film medium. Enhanced fluorescence radiation is emitted from those parts of the sample volume that present at the locations of XSW field antinodes. This variant of the XRF technique is referred as grazing incidence X-ray fluorescence (GIXRF). The technique offers high accuracy for the determination of the density variation in a thin film medium. The GIXRF analysis not only provides dimensional visualisation for nanostructured materials, but it also offers depth-resolved localisation for a foreign impurity element inside a thin film medium.^{7,8} A few research groups have recently shown that GIXRF measurements can be successfully used for the determination of the average size of nanoparticles dispersed over a large surface area on a reflecting surface as well as for those embedded in a polymer matrix.⁹ In recent work, we have shown that it is possible to infer detailed information on depth-resolved chemical speciation and the electronic nature of a thin film structure if near-edge X-ray absorption measurements are carried out in combination with the XSW investigations.¹⁰

Environmental applications

TXRF measurements were carried out to determine the presence of various trace elements in ground water and coconut water samples. For this, $\sim 10 \mu\text{L}$ volume of two water specimens were pipetted onto a cleaned quartz glass substrate after adding Ga as an internal standard element (35 ppm) and without employing any dilution procedure. The dried residue of the water was then directly employed for TXRF excitation. Figures 1(a) and 1(b) illustrate the measured TXRF spectra of the ground water and coconut water samples, respectively. By comparing the two spectra, it can be seen that coconut water contains several trace elements in larger amounts than ground water. It is known that coconut water provides a rich dietary source of cytokinins and plant hormones that offer anti-cancer, anti-aging and anti-thrombolytic benefits in humans. Table 1 summarises and compares the determined concentrations of various trace elements present in the coconut and ground water samples.

Characterisation of nanomaterials

Nanostructured thin films

As discussed above, angle dependent TXRF, often referred as GIXRF, can be successfully used to evaluate the microstructural properties of flat optical surfaces and thin layered materials. In particular, the technique is very effective

in determining structures of nanolayers deposited on flat polished Si wafers. With recent advancements in the thin-film growth technologies, considerable interest has been focused on the fabrication of superior-quality, thin, nano-structured materials that have better surface–interface properties and improved layer thickness homogeneity. Combined X-ray reflectivity and GIXRF measurements allow structural parameters (e.g. thickness, surface roughness, film density) to be determined as well as depth-resolved distribution of unwanted foreign impurity elements, *if any*, embedded inside the thin film medium.¹¹ Figure 2 shows a computed XRR pattern for a CuO (4 nm)/Cu (30 nm) bilayer thin film medium, deposited on a Si substrate. The lower frequency fringe oscillations (Kiessig fringes) in the XRR pattern give structural information on the thin CuO film medium, whereas high frequency oscillations provide structural information of the thick Cu film medium. The XRR-GIXRF measurements can be reliably used to analyse a heterogeneous thin film structure comprising of different surface and interface properties.

Analysis of nanoparticles

The nature of dispersion of nanoparticles on a flat surface (see Figure 3) is governed by many complex short-range forces. Depending upon the surface chemistry and available cohesive and adhesive forces between different parti-

Table 1. Determined concentrations of various trace elements in the water and coconut water. All quantities are in (mgL^{-1}), ($1 \text{ mgL}^{-1} = 1 \text{ ppm}$).

| Element | Ground water | Coconut fruit water | WHO guidelines (for drinking water) |
|------------------------|--------------|---------------------|--|
| Cl | 0.04 | 265 | ≤ 5 |
| K | 0.37 | 1367 | Not defined ^a |
| Ca | 3.0 | 68.0 | ≤ 100 , (100–300 may change taste of water) |
| Ti | 0.17 | — | |
| V | — | 0.03 | |
| Cr | 0.003 | 0.023 | ≤ 0.05 |
| Mn | 0.012 | 1.7 | ≤ 0.4 |
| Fe | 0.55 | 1.8 | 0.5–50 |
| Ni | 0.08 | 0.158 | ≤ 0.07 |
| Cu | 0.026 | 0.09 | ≤ 2 |
| Zn | 0.03 | 0.26 | 0.01–0.05 |
| Ga (internal standard) | 36.0 | 36.0 | — |
| Br | 0.07 | 3.6 | ≤ 0.05 |
| Rb | 1 ppb | 2455 ppb | — |
| Sr | 0.06 | 0.2 | — |

^arecommended daily requirement is $>3000 \text{ mg}$

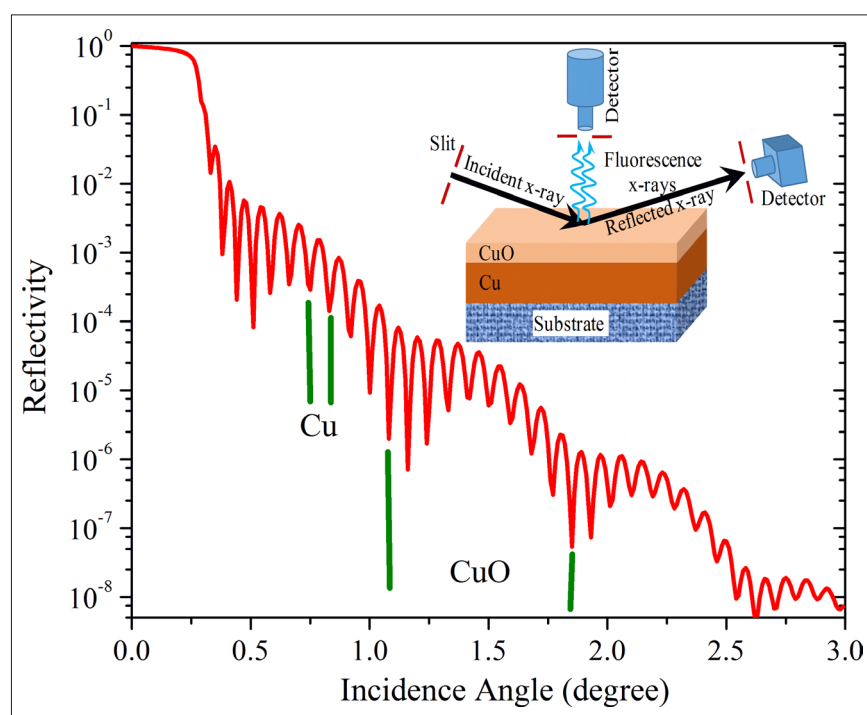

Figure 2. Computed X-ray reflectivity pattern of a CuO (4 nm)/Cu (30 nm) bilayer structure, deposited on a Si substrate surface. The computations were performed using the GUI-CATGIXRF¹¹ program assuming incident X-ray energy of 12 keV.

cles as well as between particle and substrate, the dispersion of nanoparticles on a flat surface usually follows a complex distribution profile. It might be monodisperse in nature or may follow a complex distribution of particles in the form of agglomerations. The quantitative analysis of such complex nanostructured materials is very challenging, but still a largely unexplored issue. Currently available surface characterisation techniques are not widely suitable for the morphological analysis of such complex nanostructured materials. Below, it has been shown how GIXRF measurements can be employed as a sensitive probe to characterise the nature of dispersion of nanoparticles on a flat surface.¹²

Determination of size and shape of the nanoparticles

To demonstrate the capability of the GIXRF technique for the determination of size distribution profile of the nanoparticles on a flat surface,¹³ numerical simulations have been carried out. During the GIXRF computations, Au nanoparticles of an average diameter $\sim 30 \text{ nm}$ and comprising of different particle size distribution profiles has been considered. Figures 4(a), (b) and (c) show the computed GIXRF profiles for the Au nanospheres at 15.0 keV incident X-ray energy assuming different r.m.s. variations (σ) in the particle size distribution (2 nm, 8 nm and 12 nm, respectively). From Figure 4, it can be seen that the GIXRF profile undergoes a systematic variation if the r.m.s. value of the Au nanospheres changes from 2 nm to 12 nm. The Au-L α intensity modulations in the GIXRF profiles below the critical angle ($\theta_c \sim 0.12^\circ$) change rapidly and merge together as the r.m.s. variation in the particle size is increased. In the insets of Figures 4(a), (b) and (c), distribution profiles of the Au nanoparticle as a function of their size (normalised frequency vs particle size) are shown.

Numerical simulations have also been carried out to determine how effectively GIXRF measurements can be used to distinguish different shapes of nanoparticles. To maintain a consistency in the interpretation with respect to previous results, similar sizes of the

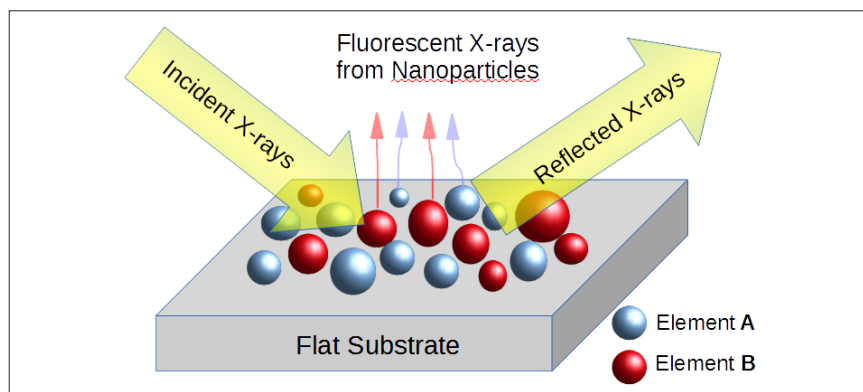

Figure 3. A schematic illustration showing the distribution of nanoparticles of different elements on top of a flat surface.

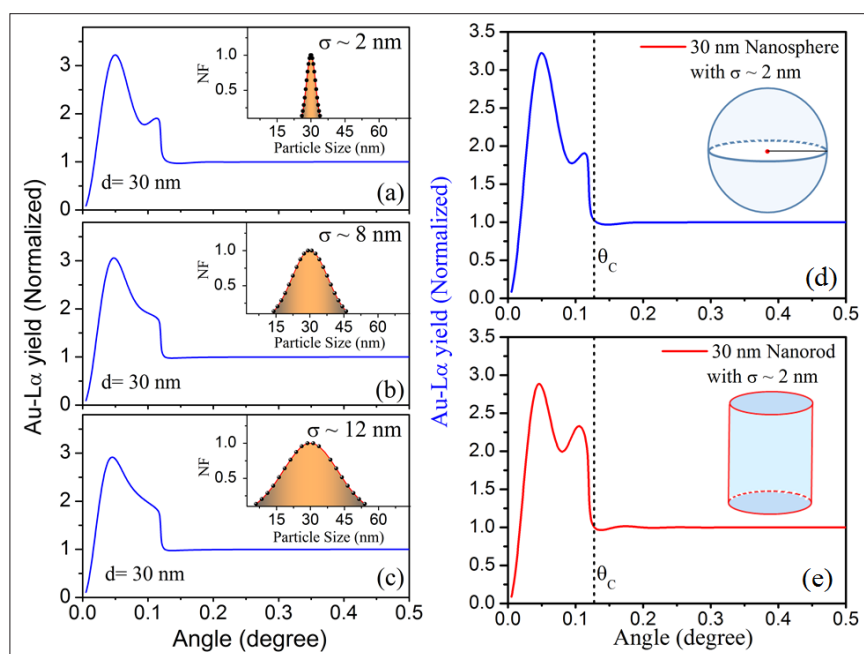

Figure 4. Computed Au-L α fluorescence profiles for the Au nanoparticles dispersed on the Si surface at incident X-ray energy of 15.0 keV. The computations were carried out assuming an average particle size of ~ 30 nm and considering different r.m.s. variations (σ) in the particle size distribution (a) $\sigma = 2$ nm, (b) $\sigma = 8$ nm and (c) $\sigma = 12$ nm. Computations were also carried out to account the effect of different shapes of the nanoparticles. (d) Nano-sphere of diameter ~ 30 nm, (e) nanorod (height = 30 nm). The figure is reproduced with permission from Reference 13, Copyright © 2017 John Wiley & Sons, Ltd.

Au nanoparticles (average diameter ~ 30 nm) were considered. During the numerical simulations, different shapes of nanoparticles were considered. Figure 4(d) represents a simulated GIXRF profile for spherical nanoparticles, whereas Figure 4(e) depicts a simulated GIXRF profile for the cylindrical shape (i.e. a nanorod). In both the cases, a r.m.s. variation in the parti-

cle size distribution of $\sigma \sim 2$ nm has been assumed. The calculations were performed considering an incident X-ray energy of 15 keV. By comparing Figures 4(d) and 4(e), it can be seen that the Au-L α fluorescence yield shows strong variations below θ_c , when the shape of the nanoparticles changes from spherical to cylindrical. These results clearly show that the shape

parameter considerably modulates the GIXRF profile of a nanoparticle. Such measurements can be successfully employed to distinguish different shapes of metal nanoparticles (e.g. nanosphere, nanorod etc.).

GIXRF measurements also allow one to evaluate whether the distribution of the nanoparticles on top of a substrate surface exhibits monodispersity or whether agglomerations form.¹⁴ Figure 5(a) shows a recorded GIXRF profile for the monodispersed distribution of Fe nanoparticles of average diameter $\sim 20 \pm 1$ nm on top of a Si substrate. Figure 5(b) demonstrates measured a GIXRF profile for an agglomerated distribution of similar Fe nanoparticles on the Si substrate surface. The insets in Figure 5 show SEM pictures in the respective cases. It can be seen here that the GIXRF measurements are fairly sensitive and can distinguish the nature of the distribution of nanoparticles on top of a substrate surface.

Conclusions

It has been shown that XRR and GIXRF are powerful and complementary tools to characterise depth-resolved, surface–interface properties of nanostructured materials deposited on top of a flat smooth surface. The technique allows one directly to estimate average particle size, particle shape, nature of dispersion of nanoparticles on a substrate surface. Element specificity is another potential feature of the GIXRF method. A single measurement is sufficient to determine the average size of the nanoparticles over large surface areas, obviating the need to perform several measurements over small regions of a specimen, which is commonly required in other conventional probes. With respect to its inherent nature, the technique can be successfully employed to analyse surface morphology of a variety of nanostructured materials, dispersed on top of a polished surface or embedded inside the bulk matrix, a few nanometres below the surface.

Acknowledgements

The author would like to thank Dr A.K. Sinha and Sh. Gangadhar Das,

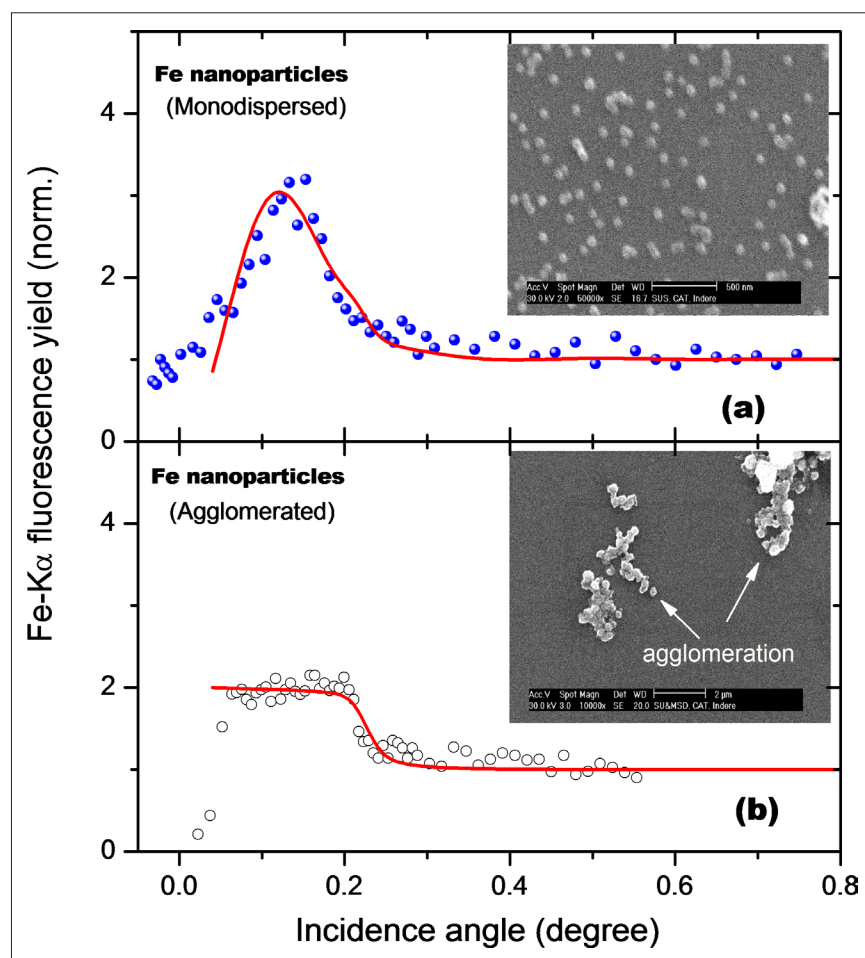

Figure 5. (a) The measured and fitted GIXRF profiles for different distribution forms of Fe nanoparticles on a Si substrate. (a) Monodispersed distribution of Fe nanoparticles and (b) agglomerated distribution of Fe nanoparticles. Scattered points show measured experimental data whereas solid red lines are the fitted GIXRF curves. The insets show SEM images of the Fe particles in each case. Reproduced from Reference 14 with the permission of AIP Publishing.

Synchrotrons Utilization Section, for the fruitful discussions and suggestions during preparation of the article.

References

- J.D. Major, M. Al Turkestani, L. Bowen, M. Brossard, C. Li, P. Lagoudakis, S.J. Pennycook, L.J. Phillips, R.E. Treharne and K. Durose, "In-depth analysis of chloride treatments for thin-film CdTe solar cells", *Nature Commun.* **7**, 13231 (2017). doi: <https://doi.org/10.1038/ncomms13231>
- C. Antoniak, J. Lindner, M. Spasova, D. Sudfeld, M. Acet, M. Farle, K. Fauth, U. Wiedwald, H.-G. Boyen, P. Ziemann, F. Wilhelm, A. Rogalev and S. Sun, "Enhanced orbital magnetism in Fe₅₀Pt₅₀ nanoparticles", *Phys. Rev. Lett.* **97**, 117201 (2006). doi: <https://doi.org/10.1103/PhysRevLett.97.117201>
- B.R. Cuenya, "Synthesis and catalytic properties of metal nanoparticles: Size, shape, support, composition, and oxidation state effects", *Thin Solid Films* **518**, 3127–3150 (2010). doi: <https://doi.org/10.1016/j.tsf.2010.01.018>
- M.K. Tiwari, G.S. Lodha and K.J.S. Sawhney, "Applications of the 'CATGIXRF' computer program to the grazing incidence X-ray fluorescence and X-ray reflectivity characterization of thin films and surfaces", *X-Ray Spectrom.* **39**, 127–134 (2010). doi: <https://doi.org/10.1002/xrs.1215>
- R.E. Van Grieken, *Handbook of X-ray Spectrometry*, 2nd Edn. Marcel Dekker, New York, pp. 433–498 (2002).
- M.K. Tiwari, A.K. Singh and K.J.S. Sawhney, "Sample preparation for evaluation of detection limits in X-ray fluorescence spectrometry", *Anal. Sci.* **21**, 143–147 (2005). doi: <https://doi.org/10.2116/analsci.21.143>
- G. Das, S.R. Kane, A. Khooha, A.K. Singh and M.K. Tiwari, "Simultaneous measurements of X-ray reflectivity and grazing incidence fluorescence at BL-16 beamline of Indus-2", *Rev. Sci. Instrum.* **86**, 055102 (2015). doi: <https://doi.org/10.1063/1.4919557>
- G. Das, S.R. Kane, A. Khooha, A.K. Singh and M.K. Tiwari, "Exploring interface morphology of a deeply buried layer in periodic multilayer", *Appl. Phys. Lett.* **108**, 263109 (2016). doi: <https://doi.org/10.1063/1.4954710>
- M. Brücher, M. Chakif, E.L. Gurevich and R. Hergenröder, "Polydisperse NiTi nanoparticles investigated by X-ray standing waves and electron microscopy—A comparative study", *Spectrochim. Acta B* **98**, 60–64 (2014). doi: <https://doi.org/10.1016/j.sab.2014.05.004>
- G. Das, A.G. Karydas, H. Ghosh, M. Czyzycki, A. Migliori and M.K. Tiwari, "Depth-resolved chemical speciation of a W-B₄C multilayer structure", *Phys. Rev. B* **96**, 155444 (2017). doi: <https://doi.org/10.1103/PhysRevB.96.155444>
- M.K. Tiwari and G. Das, "An interactive graphical user interface (GUI) for the CATGIXRF program – for microstructural evaluation of thin film and impurity doped surfaces", *X-Ray Spectrom.* **45**, 212–219 (2016). doi: <https://doi.org/10.1002/xrs.2692>
- M.K. Tiwari, K.J.S. Sawhney, T.L. Lee, S.G. Alcock and G.S. Lodha, "Probing the average size of self-assembled metal nanoparticles using x-ray standing waves", *Phys. Rev. B* **80**, 035434 (2009). doi: <https://doi.org/10.1103/PhysRevB.80.035434>
- G. Das, A. Khooha, A.K. Singh and M.K. Tiwari, "Probing nanostructured materials using X-ray fluorescence analysis", *X-Ray Spectrom.* **46**, 448–453 (2017). doi: <https://doi.org/10.1002/xrs.2777>
- M.K. Tiwari, G.M. Bhalerao, M. Babu, A.K. Sinha and C. Mukherjee, "Investigation of metal nanoparticles on a Si surface using an x-ray standing wave field", *J. Appl. Phys.* **103**, 054311 (2008). doi: <https://doi.org/10.1063/1.2885346>

Throwing light on corrosion inhibition

Malgorzata Kopec,^a Stuart B. Lyon,^b Brenda D. Rossenaar,^a Simon R. Gibbon^c and Antony N. Davies^{a,d}

^aExpert Capability Group—Measurement and Analytical Science, Akzo Nobel Chemicals B.V., Deventer, the Netherlands

^bSchool of Materials, Faculty of Science and Engineering, The University of Manchester, Oxford Road, Manchester, M1 3PL, UK

^cAkzoNobel Paints and Coatings, Felling, UK

^dSERC, Sustainable Environment Research Centre, Faculty of Computing, Engineering and Science, University of South Wales, UK

Significant research is underway globally into both improving corrosion protection as well as removing chemicals of concern from existing corrosion protection coatings. This is because the cost of corrosion in developed economies has been consistently shown to lie in the range 2–4% of Gross National Product. The most recent comprehensive study of this type, in 2002 by NACE International in the USA, estimated that the cost was \$276bn, then equal to 3.1% of US GDP.¹

For a topic of such magnitude it rarely gets the exposure it deserves except when disaster strikes. From the plague of US gas explosions and oil contamination from pipelines to tanker disasters; high-profile yacht keel failures; sewer explosions; airplane and helicopter crashes—the loss of life directly attributed to single corrosion events can be headline-grabbing. However, it is often events much closer to home, such as the perforation of domestic copper water pipes or corrosion failures on vehicles, that we are more likely to experience ourselves. Corrosion protection is an area that has historically used visual inspection and electrochemical testing methodologies. How can novel spectroscopic tools help the development of better products in this field?

How is spectroscopy helping corrosion scientists

The standard technique for examining coating performance and failure is by

visual inspection, and this approach is written into many performance standards. A more sophisticated approach combines the dielectric properties of organic polymeric coatings with the electrochemical corrosion process. DC and AC electric testing of systems using electric circuit models that link to physical processes of performance are used. In particular, methodologies such as electrochemical impedance spectroscopy (EIS) are used for the relatively rapid determination of barrier properties of coatings. However, these rely on indirect results delivered from fitting the analytical results to theoretical models to draw mechanistic conclusions. If you are using the technique for the quality control of an existing coatings formulation, where you know the long-term properties of the systems under investigation, this is a good method. However, the mechanistic link is insufficiently robust to support the development of new coatings. For example, although the electrochemical impedance response of a “perfect” organic coating resembles an electrical capacitor, coatings that are failing or interacting with their environment to actively inhibit the corrosion process produce far more complex electrical responses. Data modelling of EIS includes fitting terms associated with the coating resistance, the electrochemical double layer at the surface, the polarisation resistance to charge transfer, diffusion and other effects. It is even more challenging to unambiguously separate Faradaic

processes (i.e. those associated with corrosion reactions) from non-Faradaic process (i.e. associated with changes and breakdown of the polymeric structure). Even for a relatively simple system, the interpretation is carried out by fitting multiple, often non-linear, models to the data. As such, debate around the interpretation of the results can result. Once water penetrates a coating and active corrosion protection starts, the solutions become an order of magnitude more complex. So rather than guessing what is happening, would it not be far better to actually look into the coating and use spectroscopic analysis to follow the chemical changes within the coating and its interaction with the metal substrate?

How do protective coatings work?

A polymer coating applied to a protected surface is composed of a binder (cross-linked polymer resin such as vinyl, acrylic, epoxy, polyurethane) and additives (such as functional pigments including anticorrosive agents and other fillers). Polymer coatings provide corrosion protection in two ways: 1) they form a barrier for corrosive species and block ionic transfer between anode and cathode areas on a metal surface; 2) they act as matrices for dispersed functional pigments (i.e. for anticorrosion, appearance etc.). Active anticorrosive performance from polymer coatings is provided by the incorporation of pigments that function by being sparingly soluble or by ion-exchange

TONY DAVIES COLUMN

with the external environment. These mechanisms result in the migration of active (i.e. corrosion inhibiting) species towards the metallic substrate that delay or interrupt corrosion reactions. The most effective pigments exhibit very limited solubility in water, which prevents excessive leaching and results in long-term release to guarantee a high level of corrosion protection during the entire lifetime of the coating.

What can we currently actually see—what do we hope to see?

One of the most efficient systems with active corrosion inhibition properties involves chromate pigments. However, due to toxicity concerns, markets and regulations require the use of more environmentally-friendly, yet equally or even better-performing, alternatives. Surprisingly, despite the fact that anticorrosive pigments have been commonly used for many years, the mechanism of their performance is not fully understood; particularly when incorporated into an organic coating. Therefore, the development of new anticorrosion solutions is based on screening tests that do not consider mechanisms of processes occurring in the coatings. Corrosion inhibitors and their interactions with protected surfaces are investigated, but how they function in the coating system is not clear, especially regard-

ing their leaching and migration towards the protected surface. This is one of the main obstacles in effective development of new systems.² Notably, coatings are complex systems that also contain other pigments/fillers which can influence the migration process. A cross-section of a conventional coating system (i.e. primer + top coat) imaged using SEM (scanning electron microscopy) is shown in Figure 1(a), while the additional chemical/analytical information that can be gleaned from the application of energy dispersive X-ray spectroscopy (EDS) is shown in Figure 1(b).

How is the migration of species from the pigments within coatings actually investigated? Generally, indirectly by leaching experiments of pigmented coatings immersed in electrolyte solution, where the concentration of inhibitor in the external solution is measured using, for example, inductively coupled plasma mass spectrometry (ICP-MS). The distribution of pigments in the films and changes occurring upon water penetration and pigment leaching can be directly characterised by, for example, Raman spectroscopy, scanning electron microscopy (SEM)/EDS or scanning transmission electron microscopy (STEM)/EDS. In such a case, the depth of pigment depletion is estimated based on the analysis of cross-sections of the film after exposure. The next step is analysis of the coating systems with the pigment particles in 3D

by means of X-ray computational tomography (XCT) or SEM-based 3D sectioning techniques. XCT is a non-destructive method which allows monitoring particle distribution in the matrix, however, with limited resolution (up to 0.5 μm). SEM-based 3D imaging techniques can provide higher resolution ($\sim 5\text{nm}$), but since they are destructive, *in situ* experiments are not possible. An example of a 3D reconstruction of a coating sample with SrCrO_4 particles after a leaching experiment is presented in Figure 2. This type of analysis allows the structure of particles and voids formed after pigment leaching from the matrix to be followed.

The mechanism of pigment migration proposed recently assumed that it occurs initially through direct dissolution of pigment particles upon contact with the electrolyte, but then changes to diffusion through connected void pathways created after pigment leaching.³ Additionally, alternative mechanisms are considered, such as migration through connected pathways via the filler or other additives or connected pathways in the matrix due to its inhomogeneity.⁴

Is then the transport through the coatings possible via other pathways than connected pigment particles? The answer might be found in the polymer matrix itself, by analysing internal heterogeneity which might lead to formation of pathways for ions migration.⁵ Furthermore, screening pigment distri-

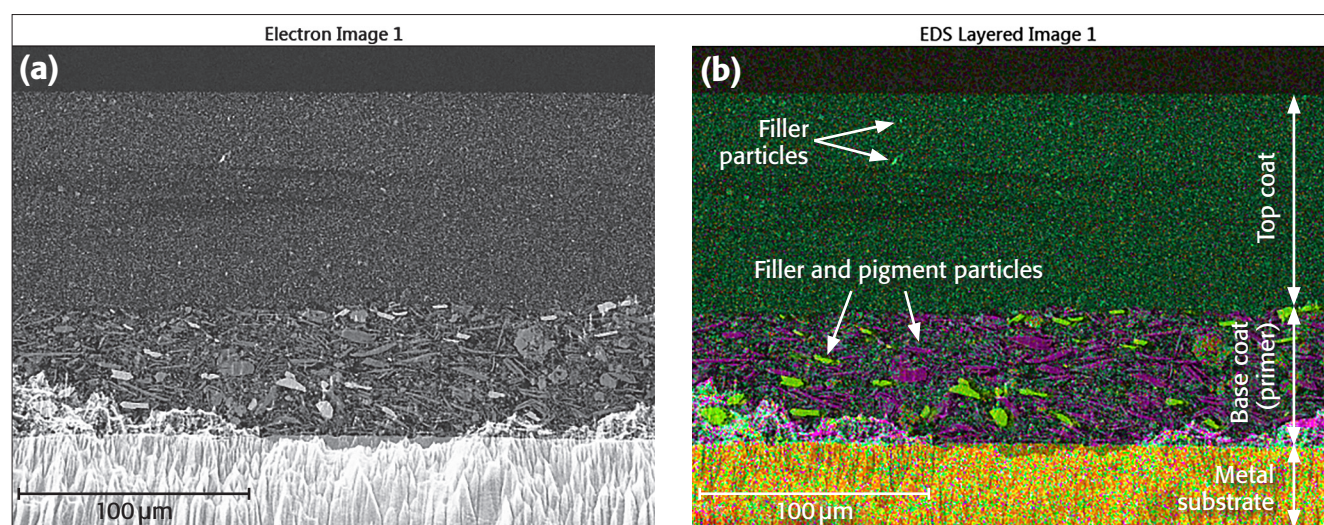

Figure 1. The cross-section of a conventional coating system (primer + top coat) on a metallic substrate imaged by SEM (a) with additional analytical information obtained from EDS (b).

TONY DAVIES COLUMN

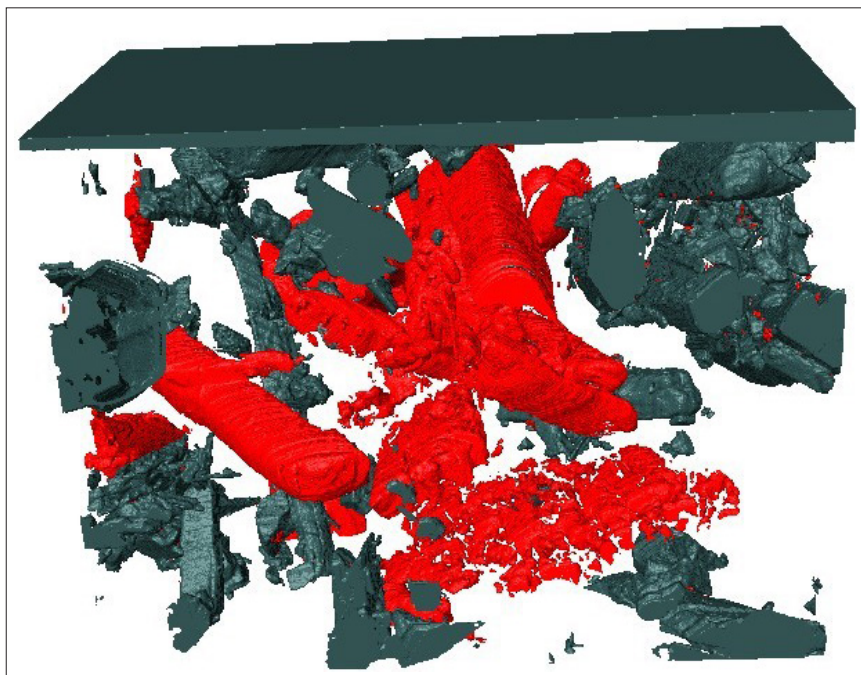

Figure 2. Coating containing 15% vol. of SrCrO_4 particles; the image was reconstructed from serial sectioning using a focused ion beam (FIB) accompanied by serial SEM imaging. SrCrO_4 particles (grey) and voids (red) are shown after exposure of the sample to NaCl solution. The field of view is $12 \times 12 \mu\text{m}$.

tribution in the polymer matrix by high-resolution 3D techniques can reveal additional connected pathways between the pigment particles.

What does the perfect future world look like?

Hopefully, we have shown that with comparatively simple data processing of the different spectroscopic analytical techniques, we can deliver substantially stronger interpretive results to support the development of better anti-corrosion systems. However, when putting presentations together this may look nice and simple, but the lack of integrated software solutions means that analysts need to be experts in at least

five different spectroscopic data analysis packages to bring this story together. Even where the data are measured on a single high-vacuum instrument, the data handling is not integrated. The recreation of the 3D images, which is critical to follow the leaching of pigments, is also carried out independently of the acquisition software. A further challenge is that, currently, the reconstruction is both a time-consuming and subjective process. Work continues to improve the algorithms and no doubt the application of machine learning could remove the subjectivity. Hopefully, the objective data it is now possible to produce using advanced 3D spectroscopic techniques will provide quantitative input

into the electrochemical modelling and help reduce the complex solution space they suffer from. Of course, in the perfect world, we would be able to carry out all the analyses in a single instrument—in real-time—and carry out the data interpretation using an integrated software suite... we can but dream!

You can learn more about analytical methods in corrosion science at the Electrochemical Methods in Corrosion Research (EMCR) conference being held from 22 to 27 July 2018 at Robinson College in Cambridge, UK. More information at <http://emcrconference.org>.

Acknowledgements

Part of this work was supported by the European Union's Horizon 2020 research and innovation programme under the Marie Skłodowska-Curie grant agreement No. 706908.

References

1. *Corrosion Costs and Preventative Strategies in the USA*. <https://www.nace.org/uploadedFiles/Publications/ccsupp.pdf> (accessed 24 January 2018).
2. S.B. Lyon, R. Bingham and D.J. Mills, "Advances in corrosion protection by organic coatings: What we know and what we would like to know", *Progr. Org. Coat.* **102**, 2–7 (2017). doi: <https://doi.org/10.1016/j.porgcoat.2016.04.030>
3. S. Sellaiyan, A.E. Hughes, S.V. Smith, A. Uedono, J. Sullivan and S. Buckman, "Leaching properties of chromate-containing epoxy films using radiotracers, PALS and SEM", *Progr. Org. Coat.* **77**, 257–267 (2014). doi: <https://doi.org/10.1016/j.porgcoat.2013.09.014>
4. A.E. Hughes, Y.S. Yang, S.G. Hardin, A. Tulloh, Y. Wang and Y. He, "Diversity of internal structures in inhibited epoxy primers", *AIMS Mater. Sci.* **2**, 379–391 (2015). doi: <https://doi.org/10.3934/mat.2015.4.379>
5. S. Morsch, S. Lyon and S.R. Gibbon, "The degradation mechanism of an epoxy-phenolic can coating", *Progr. Org. Coat.* **102**, 3–43 (2017). doi: <https://doi.org/10.1016/j.porgcoat.2016.03.019>

Theory of Sampling (TOS): *pro et contra*

Kim H. Esbensen^a and Claudia Paoletti^{b,†}

^aKHE Consulting (www.kheconsult.com) & Guest professor (Denmark, Norway, Puerto Rico)

^bDeputy Head GMO Unit, European Food Safety Authority—EFSA, Via Carlo Magno 1A - 43100 Parma, Italy.

E-mail: claudia.paoletti@efsa.europa.eu



Kim Esbensen



Claudia Paoletti

Sampling takes place every day in everybody's daily life. Consciously or unconsciously, we all take decisions regarding how to select and collect the things we need, be those vegetables or coffee in the supermarket, or material for academic research projects—with everything in between. Those who have been curious enough to reflect on everyday decision-making processes, discovered immediately that sampling decisions often make all the difference. This is why an incipient theory started to be elaborated. One individual, more brilliant than others, made a giant step forward in the evolutionary thinking on sampling and developed what became *the* Theory of Sampling (TOS); his name was Pierre Gy. We will dedicate a later column (maybe more) to focus on his life's monumental achievements. This all started in the year 1950. Here below, with the experience gained over almost 70 years, we discuss cases both *pro et contra* TOS. Readers of earlier Sampling columns will readily understand why cases *pro* TOS can be marshalled, but will rightly wonder: *why* cases *contra* TOS? Well, it is time to stray a bit outside the strictly scientific and technical issues of sampling and make an attempt to understand why TOS is not universally accepted despite being universally applicable. Here we present and discuss various motivations for taking on, or not, representative sampling or embarking on a project replacing existing sampling systems that have been found faulty and non-representative. The very first column in this series framed the key issue squarely: What is the meaning of analysing a demonstrably non-representative sample? At the time the conclusion was straightforward: There is none! In spite of this impeccable logic, proponents of TOS still often meet arguments (of bewilderingly different sorts) why one should *not* involve TOS. It is illuminating to understand what are the drivers and arguments behind this surprising attitude. Stepping into what we think are the wrong shoes, trying to understand the fundamental reasons for the existence of a strong resistance to TOS is necessary, even if not sufficient on its own, to find a more effective and successful communication strategy to explain that sampling and representativeness are the two sides of the very same coin. Hence cases *pro et contra* TOS will be presented and discussed below.

A powerful case for TOS in trade and commerce

According to international trade agreements and codes, disputes between *buyer* and *seller* are to be pre-empted by duplication (or triplication) of primary samples, of which one is analysed by the buyer, the other by the seller. A third sample is sometimes archived to be used *if* disputes can only be resolved in a court of law. Sometimes a third party is called for who then either analyses the archival sample, or is asked to perform a completely new primary sampling + analysis. Usually the two analytical results from the buyer and

seller are compared, and *should* ideally fall within a commonly agreed upon uncertainty interval, specified in the contract; the simple average value is then often used for the pertinent business purposes.

The interesting case is when analytical differences *exceed* this acceptance interval, in which case the trade codes *mandate* that the archival sample is forwarded to and analysed by a third, independent party, whose analytical result is sometimes used directly by *fiat*. If this is not acceptable to one or both parties, the dispute goes to arbitration in a court of law. This will in most cases then *dictate* to use the average between the two *nearest* of the three analytical values, upon which to conduct the salient business transaction. This arbitration approach appears logical and easy to follow, and is never questioned further—

likely because there is always a guaranteed resolution.

However, there is a hidden elephant in the room!

There are very rarely sufficient stipulations on *how* the primary samples are to be extracted. Indeed, it is commonly accepted, albeit often tacitly only, that each party or stakeholder is free to use whatever sampling procedure they prefer. The focus is overwhelmingly on the magnitude of the final analytical results. It is thus acceptable that the seller and the buyer may wish to perform sampling independently, for example having the seller sample at the port of loading of a ship's cargo, while the buyer samples the same cargo but upon arrival at the receiving port. This is so, because every pair, or every triplicate set, of primary samples is simply *assumed* to be fully representative of the cargo in question;

[†]The author is employed by the European Food Safety Authority (EFSA). The positions and opinions presented in this article are those of the author alone and do not necessarily represent the views or scientific works of EFSA.

SAMPLING COLUMN

lest the above arbitration rules fall apart. The crucial issue is that the dominating sampling error effects are invisible in the gamut of contractual stipulations—it is all about the analytical results, and perhaps, in the more thoughtful cases, also about the quality of the analytical determinations involved.

Sampling procedures for which TOS demands elimination of all bias-generating errors are not heeded (Incorrect Sampling Errors, ISE) will lead to *biased sampling*. This leaves the issue without control of the magnitude of the influence of the material heterogeneity. This will unavoidably lead to a significant *inflation* of the practical sampling variability, the more so the higher the lot heterogeneity. When one, or both, parties in an analytical dispute are *not* in compliance with the prerequisites for representative sampling, the empirical sampling variability is highly likely to be much larger than the commonly agreed upon contractual uncertainty interval (see Figure 1). This translates directly into a high probability that the analytical results from both parties cannot be resolved but will have to go to arbitration. This is the *status quo* for very many current international trade agreements, codes and contracts. The degree to which this *scheme* results in the need for arbitration is directly proportional to the inherent heterogeneity of the cargo involved, and to the degree of deviation from the principles that guarantee representative sampling. Cargoes with a small heterogeneity will rarely experience a need for arbitration, but as cargo heterogeneity goes up so will the number of cases in which comparable analytical results are not observed.

The key feature here is that the degree of heterogeneity of the lot or material, as sampled by the specific procedure in use (representative or not), is the real determinant w.r.t. the magnitude of the analytical results—*not* the aptitude of the analytical laboratories involved. Usually analytical errors are very well under control (TAE)—indeed these are practically always neglectably small compared to the dominant total sampling errors (TSE). This means that there will never be a *bona fide* common basis upon

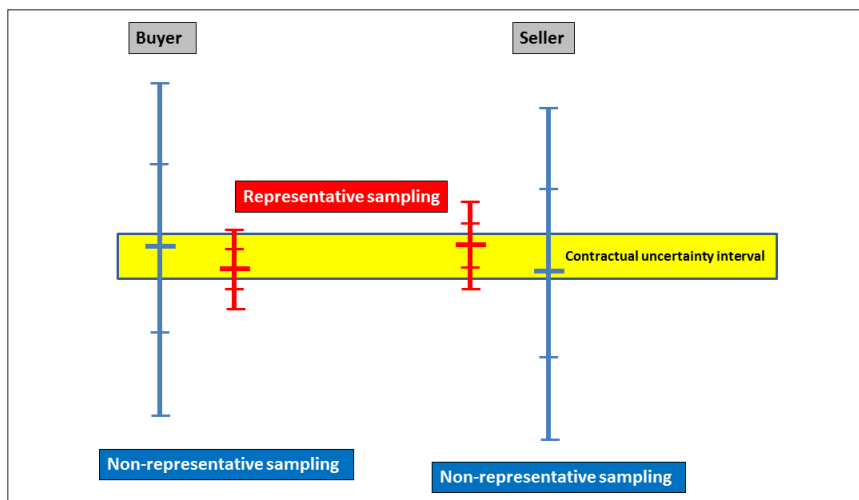

Figure 1. The consequences of non-representative sampling are identical for buyer and/or seller—an inflated sampling variability (blue) making it very difficult to be able to satisfy the contractual uncertainty interval (yellow). Things get completely out of control when both buyer and seller, and even a third arbitration party, may choose their own sampling procedure freely. Resolution of the analytical result comparison issue is only possible when all parties agree only to use representative sampling procedures (red).

which to evaluate the magnitude and the significance of the difference between any two, or three, analytical results in *all* resolution efforts. As long as there is no agreement or contract that legally *demand*s representative sampling, there will never be an objective basis, nor a rational treatment of analytical disputes. This is unfortunately the *status quo* in nearly all cases.

For both buyer and/or seller the consequence of non-representative, i.e. biased, sampling is a fatally *inflated* sampling variability (blue), compared to unbiased procedures (red); see Figure 1. Only these representative procedures are able to deliver a minimum sampling uncertainty that can be compared to the contractual uncertainty interval (yellow). Things get really out of control if/when buyer and seller, and/or an arbitration agency, can freely choose their own sampling procedure etc. There is only one way out of this hidden enigma not comprehensively recognised in current trade agreements and codes—all sampling *must* be representative, i.e. compliant with the Theory of Sampling (TOS), for example as codified in the international standard DS 3077 (2013).

The mind boggles when it is realised that a single sentence is able to rectify the fatal quagmire outlined above, a

sentence that just need to be included in all contracts forthwith when issues of sampling are on the agenda:

“All sampling procedures invoked to secure primary samples (as well as all sub-sampling operations needed to produce the analytical aliquot), whether by buyer, seller or an arbitration agency, shall be compliant with the principles of representative sampling as laid out by the Theory of Sampling (TOS), as codified in the standard DS 3077 (2013); all sampling procedures must be adequately and fully documented.”

Cases against TOS (science, technology, commerce, trade)

Unbelievably (for the present authors, and the Publisher ;-), the following statements are true [comments by the present authors in boldface parenthesis].

- “You claim that this sampler is not representative, based on a Replication Experiment characterisation—but this sampler has been in use for over 30 years—how *could* it be wrong?” [The Replication Experiment (RE) has not been understood—training, or re-training, is critical. The same imperative concerns variographic characterisation. See several previous columns in this series.]

SAMPLING COLUMN

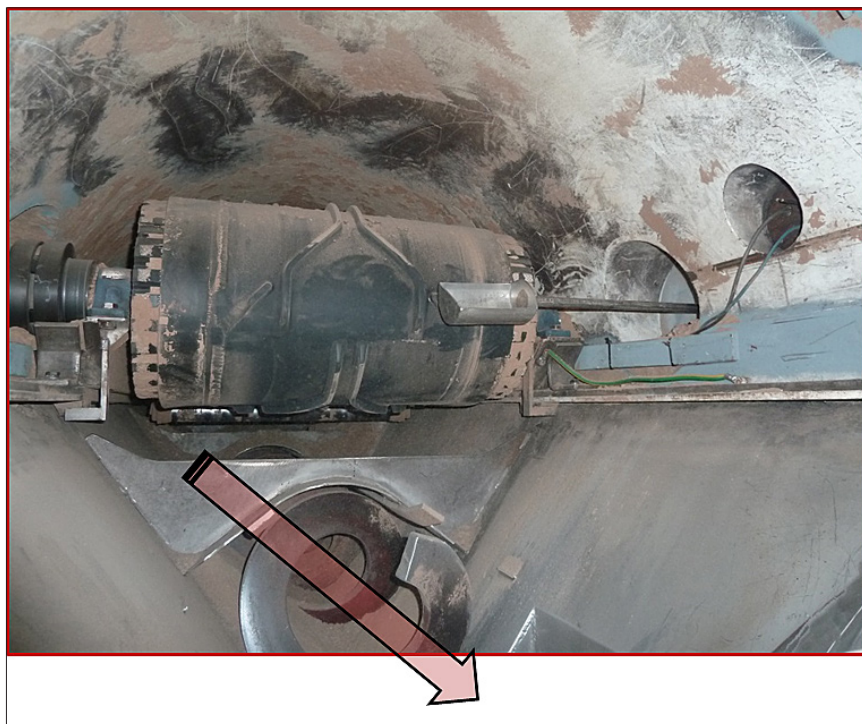

Figure 2. An attempt to design a dedicated “conveyor belt sampler”, intended to sample from a falling stream of particulate matter. Conveyor belt (top), continuing screw feeder (bottom). In between, a hopelessly inadequate scoop sampler incurring significant IDE (Increment Delineation Errors, IDE) as well as manifest IME (Increment Materialisation Errors). This scoop is totally unable to supply a continuous cross-slice of the moving stream of matter, and will manifestly be subject to severe overflow. In spite of a critical sampling audit, this sampler is still in use: “There is no room to install a replacement sampler”—*QED*.

- “I cannot tell customers that these samplers, which we have installed in our plants for decades, now “suddenly” are wrong, and need to be replaced!” [This sales person clearly has a very different agenda than being responsible for selling the customer a system that a.o. guarantees representative analytical results—this sales person must be (re-)trained re. the importance of representativeness and the economic consequences of faulty decisions. What is the meaning of analysing a demonstrably non-representative sampler? There is none!]
- “The sampling standard must be easy to follow, and to implement—or else it will not be used.” [A score of similar “simplicity arguments” against invoking TOS have been overheard in numerous standardisation committees and technical task forces, all the more incredible

as such are supposed to be staffed by the most knowledgeable and experienced experts. Crucially in this context: What is the meaning of analysing a demonstrably non-representative sampler? There is none!]

- “The TOS principles are not required in this specific ISO standard.” [—yet!] [Many sections exist in a plethora of current standards ostensibly dealing with “sampling”, but sadly with very little, or no, cognisance of TOS. Ignorance is no excuse for the law, however. What is the meaning of analysing a demonstrably non-representative sampler? There is none!]
- The client will not accept/not pay for such overly complex samplers! I will not meet my quota if insisting on invoking TOS “all of a sudden”. [It is the responsibility of the sales force to be competent wrt TOS to such a degree as to be able to explain

the consequences of buying a, say \$1 M processing plant (as an example, which is *not* a caricature) while insisting on installing demonstrably non-representative samplers. What is the meaning of analysing a demonstrably non-representative sampler? There is none! It is the responsibility of the pertinent sales force supervisors to ensure that front-line sales personal have adequate TOS skills.]

- “There is no room for a replacement sampler—the ceiling is too low... It is prohibitively costly to raise the roof on the building.” ... [Let these statements be placeholders for a slew of similar “practical arguments” why a representative sampler simply cannot be considered. Clearly economics goes before representativity here—but what is the meaning of analysing a demonstrably non-representative sampler? There is none!]
- Tradition has always been *not* to cut a full slice of the stream of matter across the whole width of the flow. There is simply not space around the conveyor belt to allow the sampler to reach all across. [Any responsible person involved *must* be able to explain the fatal consequences of allowing incorrect sampling errors to influence the sampling process, and indeed of using a manual sampling process. Practicality, perceived technical difficulty, economics, logistics... and a host of other contra arguments cannot be the driver behind primary sampling—only representativity can. What is the meaning of analysing a demonstrably non-representative sampler? There is none!]
- “Do you really think that Gy was the only one to understand sampling? You guys have been *brain-washed*. Sampling can be carried out in many ways, and they all work”. [The first part of this statement is just brash and personal, showing a complete lack of understanding of TOS; we leave it on the futile scrap heap

SAMPLING COLUMN

The efficiency argument in the laboratory

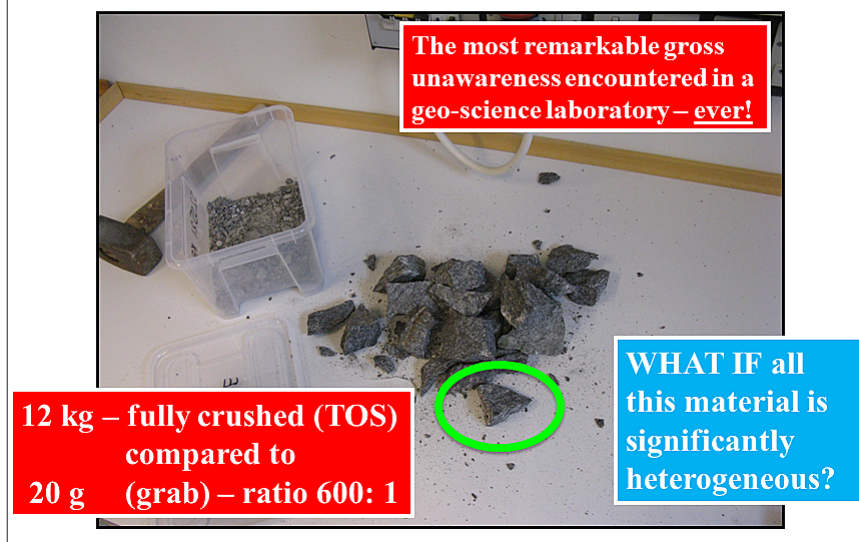

Figure 3. Scene from a geo-science analytical laboratory (sample preparation front room). The full content of the white plastic container (left), a carefully collected composite sample (12 kg), is in the process of being coarse-crushed in a study aimed at illustrating the value of proper TOS procedures in the laboratory steps of the complete “from-field-to-aliquot” pathway. Unbelievably, an authoritative laboratory stakeholder suggested, with conviction and strength: “It is not necessary to go such lengths as to crush all this material (for each field sample)—just pick and crush a ‘suitable fragment’ of the mass commensurate with the subsequent fine-crushing capacity (20 g)—this saves a lot of work!” This statement encapsulates the wide-spread work efficiency argument to the extreme, combined with blatant neglect of the main characterisation of rocks: heterogeneity—alas with catastrophic results in the form of a 1/600 reduction of the coverage of the significantly heterogeneous material. “Luckily” (in fact not by luck alone...), the laboratory student assistants were well trained wrt TOS and rejected this proposal firmly.

of personal insults. The second part represents a complete lack of demonstrable evidence—while on the contrary the TOS community has always gone out of its way to show *why* “other theories of sampling” in fact do not lead to representativity, witness, for example, the complete literature curriculum cited in these columns.]

- Linking a discipline to a person is scientifically wrong—a plurality of views is a key value in science. [At first view this “argument” would appear to contain a substantive general warning—but it is in fact a gross misrepresentation in the case of TOS. It takes an in-depth discussion to treat this statement with the seriousness it deserves, which is left to a later column dedicated to the scientific achievements of Pierre Gy.]

- “Applying TOS costs too much money—the current sampling protocol has been in use for 20 years and there has never been any complaint! We are not going to change everything today without solid economic evidence. [A plethora of solid evidence of economic losses due to faulty sampling exists in the TOS literature. Any TOS-competent proponent is able to run a Replication Experiment (RE) or a variographic experiment, estimating the effective sampling variability in a jiffy, given the relevant data; from this, economic gains or losses are easily calculated. Later columns will supply this kind of counter-arguments, complete with the critical economic results.]
- “Have you ever seen a shipment of grain? Do you really mean that we are to *ensure* that every single

grain has the same probability of being sampled?” [This statement is unaware of the critical role played by the Fundamental Sampling Principle. The key TOS tenet is only to sample where ship cargoes are in an effective 1-D transportation state, e.g. in a grain elevator, in a pipe-line or on a conveyor belt, see earlier columns.]

Many more illustrative statements can be marshalled, all in the same tune: anything *but* representativity is considered acceptable drivers for sampling! Obviously, if the reader has been with the authors in all columns so far, this state-of-affairs cannot be more wrong, however.

Que faire?

Education, outreach, TOS courses, didactic and convincing scientific and technological publications, guest appearances at symposia, conferences, annual meetings in ever more diverse application fields in science, technology and industry!

The last 15 years has seen an explosion of achievements within all of the above areas, at all levels from the very first awareness of a need for TOS... to whole textbooks; in the latter category alone at least three are in production at the time of writing. But less will also do, even much less. Here follows a selection of easily available sources from which to educate oneself in all matters re. TOS (all of which also refer to more in-depth sources).

Important reading

DS 3077. Representative Sampling—Horizontal Standard. Danish Standards (2013). <http://www.ds.dk>

Sampling Columns in *Spectroscopy Europe*; see complete list at <https://www.spectroscopyeurope.com/sampling>

Proceedings of the World Conference on Sampling and Blending series; the proceedings of the 7th conference are freely available: <https://www.impopen.com/wcsb7>

Issues of the sampling community's newsletter, *TOS forum*: <https://www.impopen.com/tosf>

IMAGING

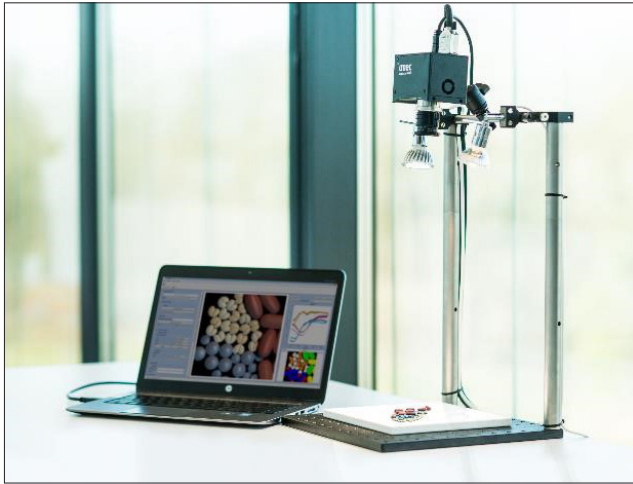

High-speed ultrasonic hyperspectral imaging camera

Imec has introduced its second generation, high-speed Snapscan hyperspectral imaging camera. This uses an ultrasonic speed piezo motor stage and innovative software to enable the acquisition of high-resolution, hyperspectral images in less than 200 ms. The Snapscan camera handles all scanning internally using the miniaturised ultrasonic piezo scanning stage, thereby avoiding the need for external scanning movement. A spatial resolution of 3650×2048 px (7Mpx), with a spectral resolution of 150+ spectral bands, can be achieved over the 470–900 nm and 600–975 nm spectral ranges. With imec's proprietary hyperspectral imaging acquisition software, specific spectral regions of interest can be selected, enabling the acquisition of images at the high speed of 200 ms. Flat signal-to-noise ratios of 200 : 1 over the full spectral range are possible, with optimised acquisition and lighting set-up parameters.

Imec

► <http://link.spectroscopyeurope.com/30-W-006>

Snapshot imager

BaySpec has introduced the GoldenEye Snapshot imager, which covers the extended wavelength range from 400 nm to 1700 nm. It features high sensitivity as compared to other imagers, and is particularly suitable for low light level applications, such as fluorescence imaging.

BaySpec

► <http://link.spectroscopyeurope.com/30-W-009>

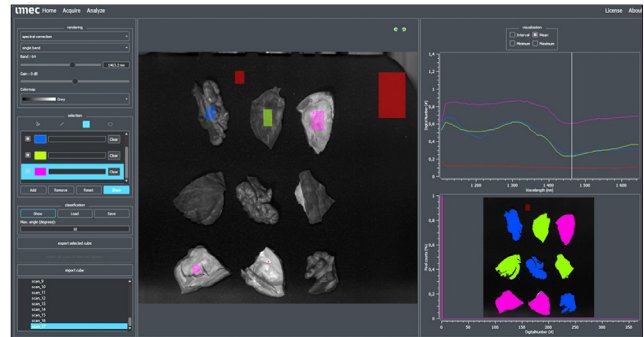

Hyperspectral imaging in the SWIR range enables classification of nuts versus their nut's shells.

Imec demonstrates SWIR hyperspectral imaging camera

Imec has developed its first shortwave infrared (SWIR) range hyperspectral imaging camera. It integrates CMOS-based spectral filters together with InGaAs-based imagers. For a number of years, semiconductor CMOS-based hyperspectral imaging filters, designed and manufactured by Imec, have been integrated monolithically onto silicon-based CMOS image sensors. This has a sensitivity range of 400–1000 nm, however, it is expected that more than half of commercial multi- and hyperspectral imaging applications need discriminative spectral data in the 1000–1700 nm SWIR range. Imec's initial SWIR range hyperspectral imaging cameras feature both linescan "stepped filter" designs with 32–100 or more spectral bands, as well as snapshot mosaic solutions enabling the capture of 4–16 bands in real-time at video-rate speeds. Cameras with both USB3.0 and GIGE interfaces are currently being tested.

Imec is a research centre and its developments are used by camera vendors and other manufacturers who integrate the technology into their products.

Imec

► <http://link.spectroscopyeurope.com/30-W-006>

NEW PRODUCTS

MASS SPECTROMETRY

Non-derivatised MS/MS method for newborn screening

PerkinElmer's NeoBase 2 MS/MS kit has now obtained CE mark approval allowing its distribution in Europe. The kit is intended for the semi-quantitative measurement and evaluation of amino acid, succinylacetone, free carnitine, acylcarnitine, nucleoside and lysophospholipid concentrations. The kit is used to analyse newborn heel prick blood samples dried on filter paper in association with a tandem mass spectrometer. The NeoBase 2 MS/MS kit can test for up to 57 analytes, including markers for screening of X-linked adrenoleukodystrophy (X-ALD), the most common peroxisomal disorder. It can also screen for adenosine deaminase severe combined immunodeficiency (ADA-SCID), which is caused by a deficiency of the enzyme ADA and is the second most common SCID. The kit enables a simple three-step assay workflow to be used from a single dried blood spot punch.

PerkinElmer

► <http://link.spectroscopyeurope.com/30-W-008>



Sciex launches tandem mass spectrometers for clinical diagnostics laboratories

Sciex Diagnostics, the *in vitro* diagnostics division of Sciex, has launched the Citrine™ Triple Quad™ MS/MS and Citrine™ QTRAP® MS/MS systems for clinical diagnostics. The Citrine system is designed for clinical labs that require high sensitivity, throughput, wide dynamic range and the ability to employ simplified sample preparation. The Citrine MS/MS system enables trace level analysis, comprehensive panels and the measurement of both large and small molecules. Triple quadrupole and QTRAP models of the system are available, each offering the sensitivity to measure metabolites and biomarkers at picomole concentrations. In addition, the QTRAP technology enables workflows that provide quantitative and qualitative analysis in a single injection, and allow the use of selective MRM³ quantitation to eliminate interferences.

The system is powered by the Analyst®MD software, for intuitive instrument control and data processing. The second generation IonDrive™ Turbo V ionisation source provides robust performance when analysing even the most complex biological samples, maximises uptime and enables the use of simpler sample preparation strategies.

The system offers electrospray ionisation (ESI) and atmospheric chemical ionisation (APCI) options, an extended mass



range up to m/z 2000 and a wide linear dynamic range, measurement of a large variety of polar and non-polar biomarkers and metabolites in biological fluids, over a large range of concentrations.

Sciex Diagnostics

► <http://link.spectroscopyeurope.com/30-W-003>

NEW PRODUCTS

RAMAN

TSI ChemLogix Raman instruments integrated with Spectragryph software

TSI ChemLogix has integrated its Raman spectroscopy instruments directly with Spectragryph software. Spectragryph is a universal interactive optical spectroscopy software, developed by Spectroscopy Ninja and used by scientists and researchers worldwide. The TSI ChemLogix Raman spectroscopy product line includes handheld, portable, benchtop and gas-phase process Raman spectrometers. New capabilities from the integration include analysing and visualising multiple spectra simultaneously, batch processing of spectra, drag and drop interface and one-click data exporting.

TSI ChemLogix

► <http://link.spectroscopyeurope.com/30-W-005>



UV/VISIBLE

New, automated UV/visible spectrophotometers

The Thermo Scientific Genesys 50 UV/vis spectrophotometer features a simplified user interface and a high-resolution, colour touchscreen; and the rugged exterior is designed with sloping surfaces to shed spills. It has a single cell configuration for low sample throughput needs, with a removable, washable sampling compartment for easy clean up. The Genesys 150 UV/vis spectrophotometer includes the same features as the Genesys 50 spectrophotometer as well as providing automation for high-throughput options and room-light resistance, allowing lid-open operation designed for improved speed and convenience over previous generation instruments. The Genesys 180 has the capabilities of the Genesys 150 spectrophotometer and also includes an eight-cell changer for higher throughput environments and double-beam capability for advanced experiments with a changing reference. The Thermo Scientific BioMate 160 UV/vis spectrophotometer also includes all the benefits of the Genesys 150 spectrophotometer and adds pre-programmed methods for life science researchers. A new line of accessories, including automated cell changers, a Peltier thermostatted cell holder, a disposable microcell holder, a sipper and fibre optic probes, is designed to simplify sampling and accommodate high throughput and temperature control needs.

Thermo Fisher Scientific

► <http://link.spectroscopyeurope.com/30-W-007>



Miniature high-resolution OEM spectrometers

Ibsen Photonics' Freedom C series of compact, high-resolution OEM spectrometers offers resolution down to 0.15 nm in a footprint of 61 × 65 × 19 mm. The series includes a spectrometer for the ultraviolet, visible and visible-near infrared ranges all using the latest CMOS detector technology with 4096 pixels.

The spectrometers include a cylindrical lens to increase throughput and a new slit option of 5 × 750 μm. The spectrometers can be supplied with Ibsen's Digital Image Sensor Board electronics (DISB-101S), which offers fast and accurate timing control for applications like Laser Induced Breakdown Spectroscopy (LIBS).

Ibsen Photonics

► <http://link.spectroscopyeurope.com/30-W-001>

NEW PRODUCTS

X-RAY

Software for updated energy dispersive spectroscopy systems

EDAX, Inc. has introduced the latest revision of its APEX™ Analysis Software, which now is available not only for the Element, but also for the Octane Elect energy dispersive spectroscopy (EDS) systems. The latest release of the software now includes a number of new features. Advanced Reporting includes the ability to generate reports directly from APEX™ Live mode and a report designer, which provides flexible and customisable templates for the presentation of images, spectra, quantification results, text, logos and sample information. Drift Correction enables parameters to be set automatically for easy operation, along with options to save drift images and define manual reference areas for advanced correction needs. Dynamic Element Mapping includes the addition and removal of elements in Mapping and Linescan modes to show only elements of interest. CompoMaps provides live net mapping capability for the separation of elemental contributions from overlapping peaks to individual elemental maps for more accurate representations of EDS maps. Spectrum Match is now available for APEX™ together with a newly launched Smart Materials and Minerals Library option, which enables the matching of a collected "unknown" spectrum to a library of reference spectra.

EDAX

► <http://link.spectroscopyeurope.com/30-W-004>

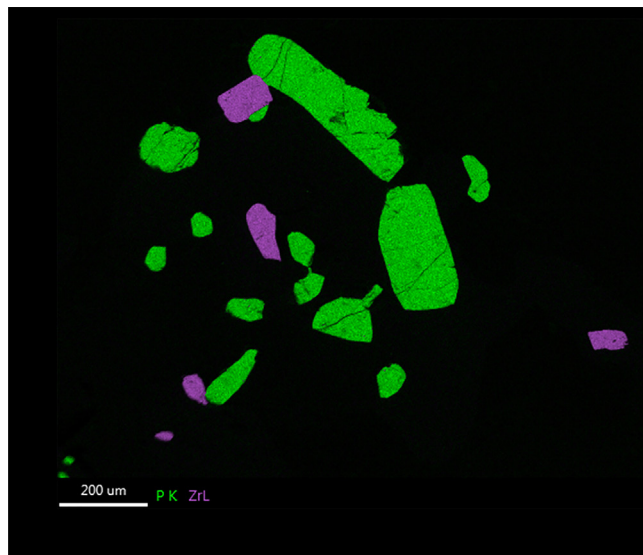

EDAX APEX™ Software CompoMap live net mapping capability.

DIARY

Conferences 2018

16–19 February, Mohali, India. **24th Conference of the National Magnetic Resonance Society of India.** Dr Kavita Dorai, ✉ nmrsindia2018@gmail.com, 🌐 <http://www.iisermohali.ac.in/web/nmrswebpage/>

18–22 February, Gainesville, Florida, United States. **14th International Bologna Conference on Magnetic Resonance in Porous Media (MRPM14).** 🌐 <https://nationalmaglab.org/news-events/events/for-scientists/international-bologna-conference>

19–24 February, Seattle, Washington, United States. **American Academy of**

Forensic Sciences (AAFS) 70th Annual Scientific Meeting. 🌐 www.aafs.org

26 February–2 March, St Petersburg, Russia. **Winter Symposium on Chemometrics (WSC-11).** Irina Yaroshenko, ✉ wsc11@chemometrics.ru, 🌐 <http://wsc.chemometrics.ru/wsc11/>

4 March–8 January, La Jolla, California, United States. **Practical Applications of NMR in Industry Conference (PANIC).** 🌐 www.panicnmr.com

18 March–22 January, New Orleans, LA, United States. **255th ACS National Meeting.** ✉ NationalMeetings@acs.org, 🌐 <https://www.acs.org/content/acs/en/meetings/national-meeting.html>

18–22 March, New Orleans, United States. **255th American Chemical Society National Meeting.** ✉ natlmgtgs@acs.org, 🌐 www.chemistry.org

22–23 March, London, United Kingdom. **11th Edition of International Conference on Proteomics.** ✉ proteomics@eurosciconmeetings.com, 🌐 <http://proteomics.euroscicon.com/>

26–29 March, Santa Fe, New Mexico, United States. **International High Power Laser Ablation Symposium (HPLA 2018).** Amy Walker, ✉ awalker@blue-52productions.com, 🌐 www.usasymposium.com/hpla

26–28 March, Miami, United States. **BIT's 6th Annual Conference of AnalytiX 2018 (AnalytiX-2018).** Ms Mia Lee, ✉

**NEW 6TH GEN
MINIFLEX**
BENCHTOP XRD WITH 2D HPAD

QUALITATIVE AND QUANTITATIVE ANALYSIS
OF POLYCRYSTALLINE MATERIALS



MiniFlex

Rigaku
Leading With Innovation

www.Rigaku.com

Supermini200
FOR ELEMENTAL ANALYSIS OF
OXYGEN THROUGH URANIUM



**BENCHTOP SEQUENTIAL
WDXRF SPECTROMETER**

Rigaku
Leading With Innovation

www.Rigaku.com

Read *Spectroscopy Europe*
on your Tablet or Phone



Search Apple's App Store or Google's
Playstore for "spectroscopy europe".

[www.spectroscopyeurope.com/
apps](http://www.spectroscopyeurope.com/apps)

SPECTROSCOPY
forum

Advertise here from £300 / €360 / \$495. Find out more at:
www.spectroscopyeurope.com/forum

mia@analytixcongress.com, ☆ <http://www.bitcongress.com/analytix2018/>

2–6 April, Phoenix, Arizona, United States. **Materials Research Society (MRS) 2018 Spring Meeting.** info@mrs.org, ☆ www.mrs.org/spring2018

8–12 April, London, United Kingdom. **51st Royal Society of Chemistry ESR Spectroscopy Group Meeting.** ☆ <http://www.esr-group.org/conferences/2018-conference-london/>

8–13 April, Vienna, Austria. **European Geosciences Union (EGU) General Assembly 2018.** EGU Executive Office, secretariat@egu.eu, ☆ www.egu.eu

11–12 April, Rotorua, New Zealand. **18th ANISG/NZNIRSS Conference.** Graeme Batten, secretary@anisg.com.au, ☆ <http://www.anisg.com.au/conference-2018>

14–18 April, Chicago, IL, United States. **Annual Meeting American Association for Cancer Research.** AACR, aacr@aacr.org, ☆ www.aacr.org

15–19 April, Estepona (Málaga), Spain. **6th International Congress on**

www.spectroscopyeurope.com

Operando Spectroscopy (Operando VI). Secretary, info@operandoconference.com, ☆ <http://www.operandoconference.com/index>

16–18 April, Berlin, Germany. **Fourth International Glow Discharge Symposium (IGDSS2018).** Peter Robinson, pete@masscare.co.uk, ☆ www.ew-gds.com

17–20 April, Glasgow, United Kingdom. **IRDG Martin & Willis Prize Meeting Spring SciX2018.** springsciX@gmail.com, ☆ <http://www.irdg.org/meetings/future-meetings/>

21–25 April, San Diego, CA, United States. **Experimental Biology 2018.** Experimental Biology, eb@faseb.org, ☆ <http://experimentalbiology.org>

24–27 April, Freising, Germany. **13th European Fourier Transform Mass Spectrometry (EFTMS) Workshop.** Prof. Dr Philippe Schmitt-Kopplin, schmittkopplin@helmholtz-muenchen.de, ☆ <https://eftms2018.helmholtz-muenchen.de>

28 April–2 May, Prague, Czech Republic. **33rd Congress International Society for**

Advancement of Cytometry. infor@cytoconference.org, ☆ <http://cytoconference.org>

29 April–4 May, Orlando, Florida, United States. **59th Experimental Nuclear Magnetic Resonance Conference.** ☆ <http://www.enc-conference.org/>

23–25 May, Vancouver, BC, Canada. **4th Annual Meeting Biophysical Society of Canada (BSC).** ☆ <http://meetings.biophysicalsociety.ca/#>

27–31 May, Edmonton, Canada. **101st Canadian Chemistry Conference.** ☆ www.csc2018.ca

27–30 May, Lecce, Puglia, Italy. **CMA4CH Meeting 7th edition Multivariate Analysis and Chemometry: an essential support for Environment and Cultural Heritage.** infocma4ch@uniroma1.it, ☆ <http://www.cma4ch.org/index2.html>

28–31 May, Belfast, United Kingdom. **Belfast Summit on Global Food Integrity.** asset2018@conferencepartners.com, ☆ <https://www.qub.ac.uk/sites/ASSET2018Summit/>

A New Website for Spectroscopy Europe

We have just launched a new website which works well on all devices from large screens to smartphones. The URL remains www.spectroscopyeurope.com.

We have migrated all users/readers from the old website but it was impossible, due to built-in security, to transfer users' passwords. I hope you have received an e-mail with a link to log in and reset your password. If you have not or are having any difficulty, here is how to log into the new site.

1) Use the Lost Password facility

From any page, click LOGIN in the main menu, and then "Request new password" to the right of the white-on-red "Log in". Enter your e-mail address and you will receive an e-mail with a "one-time" link that you can use to log in and then change the password to one you want to use. Please also check your details whilst you are in your Profile.

User account

[Create new account](#) [Log in](#) [Request new password](#)

Username or e-mail address *

[E-MAIL NEW PASSWORD](#)

The e-mail usually arrives within seconds; if you do not see it, check your spam folder(s): these types of e-mails are often mistaken for spam.

If this does not work, perhaps because your e-mail address has changed:

2) Ask for help

Just e-mail katie@impublishations.com who will check if you have an account and help you log in.

Of course, if you or a colleague don't have an account, you can quickly create one and ensure your continued access to the print version of *Spectroscopy Europe* as well as online access.

The screenshot shows the Spectroscopy Europe website homepage. At the top, there is a navigation bar with links for HOME, LATEST, CONTENT, TECHNIQUES, SUPPLIERS, APP NOTES, WEBINARS, SEARCH, LOGIN, and REGISTER FOR FREE SUBSCRIPTION. Below the navigation bar, there are several featured articles and sections. The 'LATEST ARTICLES' section includes 'Visual Image' (a raspberry), 'NIR Image' (a glass of beer), 'Total reflection X-ray fluorescence technique for multi-elemental analysis of food', and 'Synchrotron infrared near-field spectroscopy in photothermal mode'. The 'FEATURED PRODUCT' section highlights the FL51000 photoluminescence spectrometer. The 'LATEST ISSUE' section shows the cover of Spectroscopy Europe magazine. The 'LATEST NEWS' section lists various updates, including 'Unique 4-D molecular spectral maps', 'jet disintegration studied with fluorescence spectroscopy techniques', and 'Femosecond X-ray spectroscopy'. The 'NEW PRODUCTS' section lists new equipment such as the 'PTR-TOF 6000 X2 trace gas analyser', 'DuoLine rotary valve pumps', and 'Miniature high-voltage power supply module'. The 'UPCOMING EVENTS' section lists conferences like the 'International Symposium on Offaction and Electronic Noses (ISOEN 2017)' and the '4th International Conference on Environmental Radioactivity'. At the bottom, there is a footer with links for Home, Sitemap, Advertise, Contact Us, and Submit Article, along with a 'Join us on' social media icon.

www.spectroscopyeurope.com

3–7 June, San Diego, CA, United States. **66th ASMS Conference on Mass Spectrometry.** ✉ office@asms.org, 🌐 www.asms.org

10–14 June, Catania, Italy. **GEORAMAN 2018.** ✉ georaman2018@unict.it, 🌐 <https://sites.google.com/view/georaman2018/home>

10–13 June, Leon, Norway. **9th Nordic Conference on Plasma Spectrochemistry.** Yngvar Thomassen, ✉ yngvar.thomassen@stami.no, 🌐 www.nordicplasma.com

10–15 June, Glasgow, Scotland, United Kingdom. **10th International Conference on Clinical Vibrational Spectroscopy (SPEC-2018).** 🌐 <http://spec2018.com/>

15–17 June, Mali Ston, Croatia. **2nd Adriatic NMR Conference.** 🌐 <http://adriatic-nmr-conference.chem.pmf.hr/>

17–20 June, Seattle, WA, United States. **International Association for Spectral Imaging (IASIM) Conference 2018.** 🌐 <http://www.iasim18.iasim.net/>

25–29 June, Halifax, Canada. **XVII Chemometrics in Analytical Chemistry (CAC).** Peter Wentzell, ✉ peter.wentzell@dal.ca, 🌐 <https://www.cac2018halifax.com/>

26–29 June, Pau, France. **14th European Workshop on Laser Ablation (EWLA 2018).** Christophe Pecheyan, 🌐 <https://ewla2018.sciencesconf.org/>

1–5 July, Nantes, France. **EUROMAR Nantes 2018.** ✉ info@euromar2018.org, 🌐 <http://www.euromar2018.org>

2–4 July, Tihany, Hungary. **16th Hungarian–Italian Symposium on Spectrochemistry.** Viktor G Mihuez, ✉ vgmihuez@chem.elte.hu

2–4 July, London, United Kingdom. **19th Biennial National Atomic Spectroscopy Symposium.** 🌐 <http://www.rsc.org/events/detail/26021/bnass-2018-the->

[19th-biennial-national-atomic-spectroscopy-symposium](http://www.rsc.org/events/detail/26021/bnass-2018-the-19th-biennial-national-atomic-spectroscopy-symposium)

9–11 July, Bradford, United Kingdom. **British Society for Proteome Research (BSPR) Annual Scientific Meeting.** 🌐 <http://www.bspr.org/event/bspr-meeting-2018>

22–26 July, Snowbird, Utah, United States. **Solid-State NMR Symposium.** 🌐 <http://www.rockychem.com/conference/solid-state-nmr-symposium.html>

23–25 July, Milan, Italy. **2nd World Congress on Pharmaceutical and Chemical Sciences.** ✉ pharma@colossalfacet.com, 🌐 <http://colossalfacet.com/pharma-conference/>

29 July–2 August, Washington, DC, United States. **HPLC 2018: 47th International Symposium on High Performance Liquid Phase Separations and Related Techniques.** Ms Janet Cunningham, ✉ janet@barrconferences.com, 🌐 <http://www.hplc2018.org/>

18–24 August, Dublin, Ireland. **XXVIII International Council on Magnetic Resonance in Biological Systems (ICMRBS) Meeting.** ✉ icmrbs2018info@keynotepco.ie, 🌐 <http://www.icmrbs2018.org/ehome/index.php?eventid=235721&>

19–23 August, Boston, MA, United States. **256th American Chemical Society National Meeting.** ✉ natlmgtgs@asc.org, 🌐 www.chemistry.org

26–31 August, Florence, Italy. **XXII International Mass Spectrometry Conference (IMSC 2018).** Secretariat, ✉ info@imsc2018.it, 🌐 www.imsc2018.it

26–29 August, Toronto, Ontario, Canada. **132nd Association of Official Agricultural Chemists (AOAC) International Annual Meeting and Exposition.** ✉ meetings@aoac.org, 🌐 www.aoac.org

26–30 August, Liverpool, United Kingdom. **7th EuChemS Chemistry Congress.** 🌐 www.euchems.eu

10–13 September, Cambridge, United Kingdom. **39th BMSS Annual Meeting.** Lisa Sage, ✉ bmssadmin@btinternet.com, 🌐 <http://www.bmss.org.uk/bmss2018/bmss2018.shtml>

16–19 September, Philadelphia, United States. **2018 SMASH NMR Conference.** 🌐 <http://www.smashnmr.org/>

17–21 September, Rennes, France. **14th International Conference on the Applications of Magnetic Resonance in Food Science.** ✉ mrfood2018@irstea.fr, 🌐 <https://www.foodmr.org/>

23–26 September, Amsterdam, Netherlands. **Workshop on Hyperspectral Image and Signal Processing: Evolution in Remote Sensing (WHISPERS).** 🌐 <http://ieeewhisprs.com>

29 September–1 October, London, Ontario, Canada. **30th Annual Moot NMR Conference.** ✉ mootnmr@gmail.com, 🌐 <http://www.mootnmr.org/>

30 September–3 October, Orlando, FL, United States. **17th Human Proteome Organization World Congress-HUPO 2018.** Secretariat, ✉ office@ushupo.org, 🌐 <http://hupo2018.org/>

21–26 October, Atlanta, GA, United States. **45th Annual Conference of Federation of Analytical Chemistry and Spectroscopy Societies (SciX2018).** ✉ facss@facss.org, 🌐 <http://www.scixconference.org>

4–8 November, Sacramento, CA, United States. **SETAC North American 39th Annual Meeting.** ✉ setac@setac.org, 🌐 www.setac.org/

4–8 November, Indianapolis, Indiana, United States. **2018 Geological Society of America (GSA) Annual Meeting.** ✉ meetings@geosociety.org, 🌐 www.geosociety.org/meetings/

SPECTROSCOPY **READER SERVICE**

europa

Use this page to register for a free subscription to *Spectroscopy Europe*. You can also register online at the address below.

Online version at <http://www.spectroscopyeurope.com/register>

Your Details

| | |
|----------------------------|---------------|
| Title (Professor/Dr etc.): | City: |
| First Name: | State/Region: |
| Last Name: | Postal Code: |
| Job Title: | Country: |
| Organisation Name: | E-mail: |
| Address: | |

Please send me/continue to send me a free copy of *Spectroscopy Europe*. Signed: _____

Field of Work:

(please tick ALL that apply)

- Agriculture
- Analytical Chemistry
- Biotechnology
- Chemicals
- Electronics/Semiconductors
- Energy and Fuels
- Environmental
- Food
- Genomics and other -omics
- Instrumentation
- Life Science
- Materials Science
- Medical Sciences
- Metals and Minerals
- Nanotechnology
- Pharmaceuticals
- Polymers and Peptides
- Security and Forensics
- Water

Techniques:

(please tick ALL that apply)

- Atomic Absorption
- Atomic Emission
- Chemometrics
- Computers/Automation
- ICP/MS
- Infrared
- Laser Spectroscopy
- Luminescence/Fluorescence
- Mass Spectrometry
- Microscopy and Imaging
- MRI
- Near Infrared
- NMR, ESR, EPR
- Photonics and Optics
- Raman
- Separation Science
- Surface Analysis
- UV/Vis
- X-Ray Diffraction
- X-Ray Spectrometry
- None

Area of employment:

(please tick ONE only)

- Industry
- Independent Lab
- University/Institute
- Hospital
- Government
- Research Inst./Foundation
- Other _____

Job function: *(please tick ONE only)*

- Analyst
- Quality Control/Assurance
- Research Scientist
- Lab Manager
- University Professor
- Engineering/Design
- Manufacturing/Processing
- Teaching
- Marketing/Sales
- Other _____

Do you recommend, specify or authorise the purchase of spectroscopic instrumentation or services: Yes No

Your Personal Data (we will never pass your personal details to any third party)

John Wiley & Sons Ltd and IM Publications LLP will use the information you have provided to fulfil your request. In addition, we would like to:

1. Contact you by post with information and offers from relevant companies (your details are never disclosed to them). Tick here if you do NOT want to receive this:
2. Contact you by e-mail with information and offers from relevant companies (your e-mail address and details are never disclosed to them). Tick if you WANT to receive this:
3. Your registration to this website includes a regular e-mail newsletter alerting you to the latest content. Tick if you do NOT want to receive this:

Now fax this page to +44-1243-811711, or return by mail to: *Spectroscopy Europe*, 6 Charlton Mill, Charlton, Chichester, West Sussex PO18 0HY, UK.

4–8 November, Washington, DC, United States. **American Association of Pharmaceutical Scientists (AAPS) 2018 Annual Meeting.** ✉ aaps@aaps.org, ☆ www.aaps.org/annualmeeting/

2019

3–8 February, Pau, France. **European Winter Conference on Plasma Spectrochemistry.** Ryszard Lobinski, ✉ ewcps2019-chair@winterplasma2019.com, ☆ www.winterplasma2019.com

8–12 July, Auckland, New Zealand. **International Conference on Advanced Vibrational Spectroscopy (ICAVS10).** ICAVS Secretariat, Podium Conference Specialists, 2661 Queenswood Drive, Victoria, BC, Canada, V8N 1X6. ☆ <http://www.icavs.org/2019-conference/>

25–30 August, Berlin, Germany. **21st International Society of Magnetic Resonance (ISMAR) Conference joint with EUROMAR 2019.** ☆ <https://www.weizmann.ac.il/ISMAR/>

15–20 September, Gold Coast, Australia. **NIR-2019.** ☆ www.nir2019.com

13–18 October, Palm Springs, United States. **46th Annual Conference of Federation of Analytical Chemistry and Spectroscopy Societies (SciX2019).** ✉ facss@facss.org, ☆ <http://www.scixconference.org>

2020

12–18 January, Tucson, Arizona, United States. **2020 Winter Conference on Plasma Spectrochemistry.** ✉ wc2020@chem.umass.edu, ☆ <http://icpinformation.org>

Courses
2018

5–7 March, Rostock, Germany. **Short Course of the EU FT-ICR MS Network.** Christin Kuehl, ✉ christin.kuehl@uni-rostock.de, ☆ <https://tinyurl.com/yby7f489>

6–8 March, Berlin, Germany. **10th European Short Course on Time-resolved Microscopy and Correlation Spectroscopy.** Marta Kolonko, ✉ trfcourse@picoquant.com, ☆ <http://www.picoquant.com/microscopy-course>

23–24 April, Freising, Germany. **2nd European Fourier Transform Mass Spectrometry (EFTMS) School.** Prof. Dr. Philippe Schmitt-Kopplin, ✉ schmittkopplin@helmholtz-muenchen.de, ☆ <https://eftms2018.helmholtz-muenchen.de/>

Exhibitions
2018

25 February–1 March, Orlando, FL, United States. **68th Pittcon 2018.** ✉

pittconinfo@pittcon.org, ☆ <http://pittcon.org>

18–21 March, Dubai, United Arab Emirates. **ARABLAB 2018.** ✉ info@arablab.com, ☆ <https://www.arablab.com/>

28–29 March, Lyon, France. **Mesures Solutions EXPO2018.** ☆ <https://mesures-solutions-expo.fr/>

10–13 April, Munich, Germany. **Analytica 2018.** ✉ info@analytica.de, ☆ <http://www.analytica.de/>

11–15 June, Frankfurt on the Main, Germany. **ACHEMA 2018.** ✉ achema@dechema.de, ☆ <http://www.achema.de>

31 October–2 November, Shanghai, China. **Analytical China 2018.** Barbara Kals, ✉ barbara.kals@messe-muenchen.de, ☆ <https://tinyurl.com/yd99eqox>

2019

7–9 May, Beijing, China. **AchemAsia 2019.** China National Convention Center, Tianchen East Road, Chaoyan District, Beijing 100105, China, ☆ <http://www.cncchina.com/>

ADVERTISERS INDEX

| | |
|--|----|
| IASIM 2018 | 3 |
| IMSC 2018..... | 7 |
| Jeol..... | 2 |
| Princeton Instruments..... | 36 |
| Shimadzu..... | 5 |
| Starna Scientific..... | 9 |
| www.spectroscopyeurope.com | |

Have You Heard?

“*Such ingenious CUBES!
That cooled CCD is impressive!
Look at the aberration-free spectra!
So small and easy to use!*”



FERGIE's footprint is smaller than the page you're reading now!

High-performance spectroscopy can be easy!

FERGIE™, from Princeton Instruments, provides the latest high resolution, high signal-to-noise ratio hyperspectral imaging capabilities. Innovative, pre-aligned accessories make setup easy.

Join the many **educators** and **researchers** who are embracing this revolution in spectroscopy!

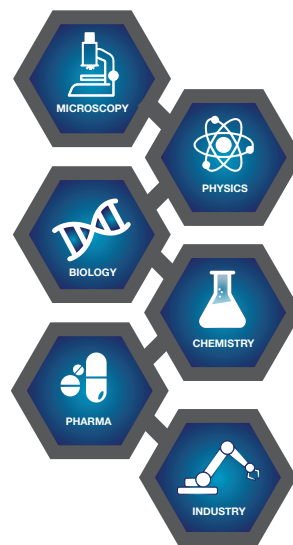

“The FERGIE is going great for us. I still can't believe how good the data is!”

– Dr. Mark Waterland, Massey University, New Zealand



Global Sales & Support

www.princetoninstruments.com

info@princetoninstruments.com

tel: +1 609.587.9797